



**POLARIS**  
***GENERAL***



**POLARIS**

**2026**

ENGLISH VERSION

POLARIS  
**GENERAL**

# TOUGH DOESN'T QUIT

When you invent categories, your work is never finished. We're riders, relentlessly chasing the next ride. It's race-inspired performance that propelled our people to podiums at DAKAR and the Baja 1000, or a crew of relentless explorers who want to break free from the everyday and get deep into the backcountry. Tough doesn't stop when the light fades, tough doesn't settle for second place and tough doesn't quit.



# 2026 LINEUP

SEE THE FULL LINEUP AT [POLARIS.COM/GENERAL](https://www.polaris.com/general)

POLARIS  
**GENERAL**

## GENERAL XP 1000

### XP 1000 SPORT (2 & 4 SEAT)



100 HORSEPOWER  
14" SUSPENSION TRAVEL WITH  
HIGH CLEARANCE A-ARMS  
4,500 LB WINCH  
POLY SPORT ROOF  
SPORT LOW PROFILE FRONT BUMPER  
30" PRO ARMOR CRAWLER XGF/XG

### XP 1000 PREMIUM (2 & 4 SEAT)



**XP 1000 STANDARD FEATURES PLUS:**  
ROCKFORD FOSGATE® STAGE 1 AUDIO  
WITH PMX HEAD UNIT  
CONVEX REARVIEW MIRROR  
PADDED CENTER CONSOLE

### XP 1000 ULTIMATE (2 & 4 SEAT)



**XP 1000 STANDARD FEATURES PLUS:**  
7" DISPLAY POWERED BY RIDE COMMAND  
WITH INTEGRATED REARVIEW CAMERA  
ROCKFORD FOSGATE® STAGE 3 AUDIO

## GENERAL 1000

### 1000 SPORT (2 SEAT)



100 HORSEPOWER  
600 LB DUMPING CARGO BOX  
HALF DOORS  
ELECTRONIC POWER STEERING (EPS)  
VERSATRAC TURF MODE

### 1000 PREMIUM (2 SEAT)



**1000 SPORT FEATURES PLUS:**  
FOX® 2.0 PODIUM QS3 SHOCKS  
LED HEADLIGHT WITH ACCENT  
& LED TAILLIGHTS  
14" WHEELS AND 27" MAXXIS  
CORONADO TIRES

## 04 2026 OVERVIEW

- 06 POLARIS GENERAL MODELS
- 08 RIDE COMMAND
- 10 POLARIS ENGINEERED PARTS & ACCESSORIES

## ACCESSORIES & MAINTENANCE

- 18 WINDSHIELDS & REAR WINDOWS
- 20 DOORS
- 22 ROOFS
- 23 VEHICLE PROTECTION
- 24 STORAGE
- 27 CAB COMFORT
- 28 WINCHES
- 29 PLOWS & TRACKS
- 30 LIGHTING
- 32 CONNECTED TECHNOLOGY
- 34 AUDIO
- 36 HUNT
- 38 COOLERS
- 40 WHEELS & TIRES
- 46 TIRE SEALANT & TRAILERING

## MAINTENANCE & GARAGE

- 48 MAINTENANCE PARTS & FLUIDS
- 50 OIL & LUBRICANTS
- 52 GARAGE ACCESSORIES
- 54 BATTERY CHARGERS
- 55 SERVICE PARTS
- 56 HEAVY DUTY PARTS

## APPAREL

- 59 JERSEYS & GLOVES
- 59 HATS & GAITERS
- 60 OUTERWEAR & CASUALWEAR
- 61 HELMETS & GOGGLES

## 62 2026 LINEUP & SPECIFICATIONS

**BUILD YOUR OWN**  
[AT POLARIS.COM/GENERAL](https://www.polaris.com/general)

***GENERAL***

**UNCOMPROMISING  
VERSATILITY  
TO DO MORE**



Experience more outdoors with GENERAL, the bestselling crossover side-by-side built for having fun and getting things done. Take on new trails. Quickly tackle tasks. With exceptional versatility, performance and comfort GENERAL is the ultimate do-it-all machine.



### VERSATILITY

TOW. STOW. AND GO. | Bring what you need for outdoor activities with impressive towing capabilities, seating for up to 4 and a dump box that fits more supplies and gear.



### COMFORT

THE RIDE HAS NEVER FELT BETTER | Stay energized on all-day rides with enduring comfort. Responsive steering, up to 14" of usable suspension travel and bolstered bucket seats deliver an effortless experience off road.



### PERFORMANCE

GET OUT THERE AND THEN SOME | An ideal combination of trail-capable power, terrain-smoothing suspension and ample ground clearance enable near limitless exploration.



# GENERAL

## CAPABILITY TO MATCH YOUR AMBITION

### GENERAL XP 1000

**UNLOCK NEXT-LEVEL VERSATILITY.** Elevate your experience with more height from a 64" stance, high clearance A-arms, a 4,500 LB HD Plus winch and available industry-leading technology. Available in 2-seat and 4-seat.

#### VERSATILITY

600 LB dumping cargo box to haul camping gear or tools  
13.5" of ground clearance and 30" tires to navigate over obstacles  
VersaTrac Turf Mode protects your yard while knocking out tasks

#### COMFORT

14" of suspension travel smooths out rough trails  
Adjustable seats and tilt steering allow you to dial in for the perfect fit  
RIDE COMMAND, including GPS mapping and Group Ride for navigation across different terrain\*  
Rockford Fosgate® Premium Audio to bring your favorite music along for the ride\*

\*Select trims

#### PERFORMANCE

Ultra-responsive 100 HP engine for corner-to-corner trail exploring fun  
4,500 LB winch featuring synthetic rope to clear obstacles when out on the ride  
1,500 LB tow capacity to pull a trailer or drag logs off the trails  
True On-Demand AWD/2WD delivers quick gripping traction



GENERAL XP 1000  
SPORT



GENERAL XP 1000  
PREMIUM



GENERAL XP 4 1000  
ULTIMATE



# GENERAL 1000

**TACKLE TRAILS AND TASKS.** Pack everything you need for work or fun with a 60" stance, 1,500 LB towing capacity, 600 LB dumping cargo box and up to 13.2" of usable suspension travel. Available in 2-seat.

## VERSATILITY

- 600 LB dumping cargo box to haul gear or tools
- 12" of ground clearance and 27" tires to navigate over obstacles
- VersaTrac Turf Mode protects your yard while knocking out tasks

## COMFORT

- 12.25"/13.2" of suspension travel deliver to soak up terrain when exploring trails
- Adjustable seats and tilt steering allow you to dial in for the perfect fit
- Half doors help keep you protected from the elements

## PERFORMANCE

- Ultra-responsive 100 HP engine for performance on the trails and for work
- 1,500 LB tow capacity to pull a trailer or drag logs off the trails
- True On-Demand AWD/2WD delivers quick gripping traction



GENERAL 1000  
SPORT



GENERAL 1000  
PREMIUM



## MAKE IT TRULY YOURS

Choose from a variety of tested and trusted Polaris Engineered accessories to customize your GENERAL for how you ride.

[SCAN TO LEARN MORE](#)

# OFF ROAD, IN TOUCH





# POLARIS RIDECOMMAND

## ENHANCE YOUR RIDE

Take your ride to the next level with RIDE COMMAND. Whether you're chasing new trails or planning your next adventure, RIDE COMMAND helps you ride smarter and explore farther with confidence. Access GPS navigation, customizable gauges, Group Ride and more—right from your 7" Display, the free Polaris app or the RIDE COMMAND website. And the best part? It all works even without cell service, so you're ready for whatever comes next.

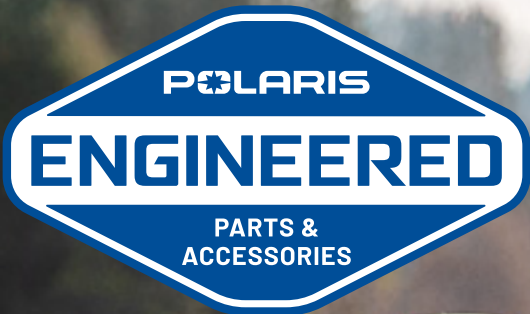

# PARTS AND ACCESSORIES DESIGNED TO FIT YOUR GENERAL

**DESIGNED**

by the people who designed your vehicle.

**TESTED**

in the field so you ride with 100% confidence.

**TRUSTED**

70 years in the business. The #1 name in off-road.

# KEEP YOUR STANDARDS HIGH. WE DO.



## WE HOLD OUR PARTNERS TO THE SAME STANDARDS

Sharing an outdoor adventure with a companion or two gives your experience its very own energy. When we meet another brand that builds and tests their products with the same rigor as we do, a kinship forms. So we give them an exclusive partner badge and invite them along for the ride. It's another way we bring you the best options for customizing your Polaris vehicle without compromise. How better to send you and your crew out into the world?



ACCESSORIES  
BACKED BY A



WARRANTY

# ENHANCE YOUR RIDE

WITH INTEGRATED ACCESSORIES

## TESTED & PROVEN



DUST



WIND

## BUILD YOUR CAB SYSTEM

STARTING ON P. 18



## COMFORT YOU HAVE TO EXPERIENCE TO BELIEVE

Our cab components create an experience-enhancing interior, offering supreme comfort to your vehicle.



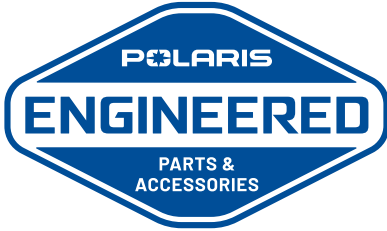

## PROFILE TUBE DESIGN

Contours built into the cage deliver a premium sealing surface.



## PERFECT FIT, PERFECT SEAL

A 360° gasket seal provides our tightest-sealing cab.



## EASY ON & OFF

Adapt to your needs and environment with exclusive toolless, easy on/off Lock & Ride components.

Look for  to identify Lock & Ride ready accessories.



## PLUG & PLAY ELECTRICAL

### EFFORTLESSLY ADD LIGHTS, HEAT, WIPERS & AUDIO.

A revolution in electrical accessory integration, the Polaris PULSE Electrical System allows for a simple plug & play approach for adding power to Polaris Engineered Accessories.



Look for  to identify Polaris PULSE ready accessories.



# BLAZE A NEW TRAIL



## TRAIL PACKAGE FEATURED ACCESSORIES:

- 2881108 Tip Out Windshield - Glass: P. 18
- 2891289  Rear Window - Glass: P. 19
- 2881992 Kick-Out Rock Sliders, 4-Seat: P. 23
- 2882144  Tip-Down Headache Rack: P. 26

- 2883126 RIGID® D-Series Pro Flood LED Lights: P. 30
- 2889790 Pro Armor 31" Dual-Row Combo LED Light Bar: P. 31
- 2883785 Polaris PULSE LED Light Bar Harness (x2): P. 31
- 2879860 Y-Harness: P. 31



SCAN TO SHOP  
THE FULL PACKAGE



2890706 Polaris NorthStar 60 QT Cooler: P. 38

2890189 Pro Armor Wheel & Tire Set:  
5301 Beadlock & Crawler XR, 30": P. 45

# PREPARE FOR THE HUNT



## HUNT PACKAGE FEATURED ACCESSORIES:

SCAN TO SHOP  
THE FULL PACKAGE



2881108 Tip-Out Windshield - Glass: P. 18

2891289  Rear Window - Glass: P. 19

2883780 Poly Sport Roof, 2-Seat: P.22

2881540 Convex Rearview Mirror: P. 27

2883126 RIGID® D-Series Pro Flood LED Lights: P. 30

2884299 RIGID® 32" SR-Series Combo LED Light Bar: P. 31

2883785 Polaris PULSE LED Light Bar Harness (x2): P. 31

2879860 Y-Harness: P. 31

2883425 Polaris NorthStar 60 QT Cooler: P. 38

2883166 Pro Armor Wheel & Tire Set:  
5201 & Attack 2.0, 30": P. 45



# ACCESSORIES THAT WORK HARD



## UTILITY PACKAGE FEATURED ACCESSORIES:

SCAN TO SHOP  
THE FULL PACKAGE



- 2884223  Full Vented Windshield - Hard Coat Poly: P. 18
- 2891288  Rear Window - Poly: P. 19
- 2891286 Canvas Upper Doors, 2-Seat: P. 21
- 2881101 Kick-Out Rock Sliders, 2-Seat: P. 23

- 2889443 Rhino-Rack® Rear Bed Rack: P. 25
- 2891204 Rhino-Rack® Eyelet Tie-Downs: P. 25
- 2885046 Pro Armor Wheel & Tire Set: 5202 & Harvester, 30": P. 45

# WINDSHIELDS

Keep the elements out and control air flow into the cab.

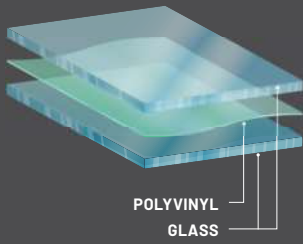

## GLASS vs POLY

Superior optical clarity (automotive level)  
 Scratch-resistant  
 Curved to fit, seals tight  
 Cold weather / heavy duty  
 Wiper-ready

Lightweight, flexible, easy to store/remove  
 Impact-resistant  
 Tight seal keeps out rain and dust  
 Hard Coat: 30x more scratch resistance than regular poly

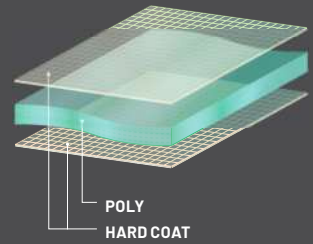

### GLASS



#### TIP-OUT WINDSHIELD - GLASS TOP SELLER

»2881108  
 GENERAL XP 1000/4 '20-26  
 GENERAL 1000/4 '16-26

#### FULL WINDSHIELD - GLASS TOP SELLER

»2889064  
 GENERAL XP 1000/4 '20-26  
 GENERAL 1000/4 '16-26

### HARD COAT POLY



#### VENTED WINDSHIELD - HARD COAT POLY

»2884223  
 GENERAL XP 1000/4 '20-26  
 GENERAL 1000/4 '16-26



#### GLASS WINDSHIELD WIPER & WASHER SYSTEM TOP SELLER

»2881090  
 GENERAL XP 1000/4 '20-26  
 GENERAL 1000/4 '16-26



Integrated vents give you the ability to add extra airflow on hot summer days or defrost your windshield on the coldest winter mornings

# REAR WINDOWS

Turbulent air forms above the cargo bed and behind the cab when you add a windshield. This swirl can carry dirt, dust, leaves and rain into the cab. Eliminate this phenomenon and control the swirl by installing a rear window.



ADD A REAR WINDOW TO REDUCE  
**DUST SWIRL**



REVOLUTIONARY  
INSTALLATION



AIRTIGHT  
GASKET SEAL

POLY



HALF WINDSHIELD - POLY

» 2881111

GENERAL XP 1000/4 '20-26  
GENERAL 1000/4 '16-26



REAR WINDOW - GLASS **TOP SELLER**

» 2891289

GENERAL XP 1000/4 '20-26  
GENERAL 1000/4 '16-26



REAR WINDOW - POLY **TOP SELLER**

» 2891288

GENERAL XP 1000/4 '20-26  
GENERAL 1000/4 '16-26

# DOORS

**COMPLETE YOUR CAB.** GENERAL comes equipped with half doors. To create an enclosed cab for increased protection from the elements, choose from two great Polaris options.



## POLARIS ENGINEERED ADVANTAGES



**PREMIUM INTERIOR HANDLE AND LINER**

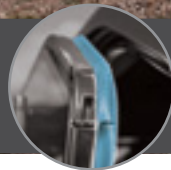

**A PERFECT FIT FOR THE PERFECT SEAL**

## REPLACE STOCK HALF DOORS

### PREMIUM POLY FULL DOORS

- Impact and scratch-resistant tempered glass
- Fully-sealed design keeps elements out for a premium in-cab environment
- Hinged window adjustability
- Soft-touch, easy-to-clean premium interior liner

#### **A** 2-SEAT

- Six-way glass window adjustability
- » 2889809

GENERAL XP 1000/4 '20-26  
GENERAL 1000/4 '16-26

#### **B** 4-SEAT

- Push-out windows
  - Kit includes B-pillar cover seal
- » 2889810

GENERAL XP 4 1000 '20-26  
GENERAL 4 1000 '17-26





## ADD UPPER DOORS TO STOCK HALF DOORS

### CANVAS UPPER DOORS

- Durable, rugged canvas stitched over a robust steel frame
- Lightweight, UV-resistant construction
- Retention straps for increased strength
- Zipper windows for increased venting options
- Mounts easily by drilling into stock doors (drill hole plugs included)

#### **C** 2-SEAT

» 2891286  
 GENERAL XP 1000 '20-26  
 GENERAL 1000 '18-26

**NOT SHOWN**

#### 4-SEAT

» 2891287  
 GENERAL XP 4 1000 '20-26  
 GENERAL 4 1000 '18-26



# ROOFS

Protect yourself from the elements. The right roof shields you from the sun and rain.

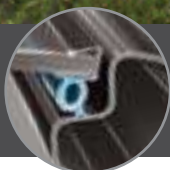

**A PERFECT FIT FOR THE PERFECT SEAL**

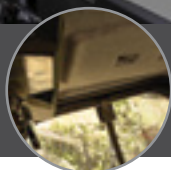

**PREMIUM FEATURES & QUIETER RIDE**



**KEEP MOISTURE MOVING**

**POLARIS ENGINEERED ADVANTAGES**

TOP SELLER

## POLY SPORT ROOF

» 2883780

GENERAL XP 1000 '20-26  
GENERAL 1000 '16-26

## POLY ROOF LINER

» 2891362

GENERAL XP 1000 '20-26  
GENERAL 1000 '16-26

Compatible with Sport Roof - Poly (2883780), sold separately

TOP SELLER

## POLY SPORT ROOF

» 2883781

GENERAL XP 4 1000 '20-26  
GENERAL 4 1000 '17-26

## POLY ROOF LINER

» 2883802

GENERAL XP 4 1000 '20-26  
GENERAL 4 1000 '17-26

Compatible with Sport Roof - Poly (2883781), sold separately



# VEHICLE PROTECTION

Arm your GENERAL with Polaris Engineered bumpers and guards to take on any challenge. Designed for easy, secure installation, while providing added protection for lights, vehicle body and suspension.



## EXPANSION ANCHOR MOUNTS

Tough expansion anchor mounts allow for quick install of rock sliders and bumpers without damaging the vehicle's frame.



UNEXPANDED



EXPANDED

## FENDER FLARES / A-ARM GUARDS

### A XL FENDER FLARES

» FRONT & REAR • 2884220

GENERAL 1000/4 '16-26  
STANDARD ON GENERAL XP MODELS  
Not compatible with Low Profile Rock Sliders

### B HIGH CLEARANCE A-ARM GUARDS

» FRONT • 2884221

GENERAL XP 1000/4 '20-26

» REAR • 2884222

GENERAL XP 1000/4 '20-26

## ROCK SLIDERS

### C KICK-OUT ROCK SLIDERS

• Compatible with XL Fender Flares

» 2-SEAT • 2881101

GENERAL XP 1000 '20-26  
GENERAL 1000 '16-26

» 4-SEAT • 2881992

GENERAL XP 4 1000 '20-26  
GENERAL 4 1000 '17-26

### LOW PROFILE ROCK SLIDERS

» 2881102 [NOT SHOWN]

GENERAL 1000 '16-26

Not compatible with XL Fender Flares

## SPORT BUMPERS

### D SPORT LOW PROFILE FRONT BUMPER

» 2881094 **TOP SELLER**

GENERAL XP 1000/4 '20-26  
GENERAL 1000/4 '16-26

### E SPORT UPPER FRONT BUMPER

» 2881525

GENERAL XP 1000/4 '20-26  
GENERAL 1000/4 '16-26

Requires Sport Low Profile Front Bumper  
Not compatible with Front Hood Storage Rack (2889157)

### SPORT REAR BUMPER

» 2884345 [NOT SHOWN]

GENERAL XP 1000/4 '20-26  
GENERAL 1000/4 '16-26

# STORAGE | RHINO-RACK®

## BRING IT ALL. BRING IT ON.\*

From opposite sides of the globe, some of the most capable machines in the off-road world meet a trusted outdoor adventure brand to deliver industry-exclusive, purpose-built bed racks and attachments that help GENERAL riders get the most out of their next adventure.



\*Always read and follow the owner's manual and on-vehicle labels for prohibited items.





## REAR BED RACK



### REAR BED RACK

- The ultimate modular load carrying solution
- Strong, lightweight aluminum construction tested in the harshest conditions
- Quickly adapt your vehicle from workday to weekend with a wide array of Rhino-Rack® attachments

»2889443

GENERAL XP 1000/4 '20-26  
GENERAL 1000/4 '16-26

## ATTACHMENTS



### GUN MOUNTING BRACKET

- Mount Kolpin Stronghold Gun Boots to Rhino-Rack® systems when paired with Auto-Latch Mount (2884106), sold separately

»2889327

GENERAL XP 1000/4 '20-26  
GENERAL 1000/4 '16-26

See P. 36 for more hunt information



### EYELET TIE-DOWNS

- Attach in multiple locations on the platform for additional tie-down points
- Anti-corrosive, galvanized steel for heavy duty strength
- Includes one set with hardware (straps not included)

»2891204

GENERAL XP 1000/4 '20-26  
GENERAL 1000/4 '16-26



### MULTI-PURPOSE TOOL HOLDER

- Carry and protect tools, paddles and more
- Ratchet-locking mechanism for quick release and rubber inserts that secure gear into place

»2889528

GENERAL XP 1000/4 '20-26  
GENERAL 1000/4 '16-26



### HIGH LIFTING JACK MOUNT

- Simple, quick install with durable brackets
- Rugged, non-corrosive powder-coated steel stands up to the harshest conditions

»2889533

GENERAL XP 1000/4 '20-26  
GENERAL 1000/4 '16-26



### 36" HIGH-LIFTING JACK

- Assists with trailside repairs or to gain leverage for getting your vehicle unstuck
- Lightweight at under 30 LBS

»2889508

GENERAL XP 1000/4 '20-26  
GENERAL 1000/4 '16-26



### CARGO CORNER BRACKET

- Mount a NorthStar cooler or toolbox to the platform and save space inside the vehicle (straps not included)
- Anti-rotation nut offers maximum security

»2889531

GENERAL XP 1000/4 '20-26  
GENERAL 1000/4 '16-26



### 200L LUGGAGE BAG

- Carry bulky, lightweight gear in this tear- and weather-resistant canvas bag

»2889881

GENERAL XP 1000/4 '20-26  
GENERAL 1000/4 '16-26



### TRACTION BOARD MOUNT

- Strong, durable and easy to attach
- Traction boards sold separately

»2889530

GENERAL XP 1000/4 '20-26  
GENERAL 1000/4 '16-26



### FLAG BRACKET

- Securely mount flags or whips to Rhino-Rack® platform
- Adjustable bracket with 180-degree folding design

»2891228

GENERAL XP 1000/4 '20-26  
GENERAL 1000/4 '16-26

# STORAGE

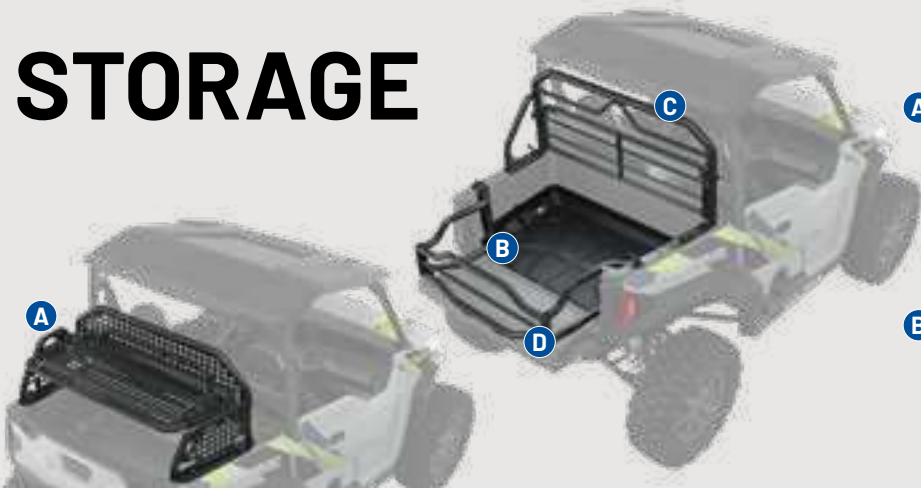

## **A** REAR ADVENTURE RACK

- Mount is solid, does not fold

» 2885113

GENERAL XP 1000/4 '20-26  
GENERAL 1000/4 '16-26

See P. 37 for more info

## **C** TIP-DOWN HEADACHE RACK

» 2882144

GENERAL XP 1000/4 '20-26  
GENERAL 1000/4 '16-26

Not compatible with Kolpin Stronghold Mount (2885114)

## **B** CARGO BED MAT

» 2881933

GENERAL XP 1000/4 '20-26  
GENERAL 1000/4 '16-26

## **D** BED EXTENDER

» 2881547

GENERAL XP 1000/4 '20-26  
GENERAL 1000/4 '16-26

Not compatible with Kolpin Stronghold Mount (2885114)

## **NEW** NORTHSTAR 30 QT COOLER STRAP

- Secures a 30 QT NorthStar Cooler to the bed of the vehicle

» 2891352



## BEHIND SEAT STORAGE BAG

» 2882164

GENERAL XP 1000/4 '20-26  
GENERAL 1000/4 '16-26

## IN-DASH STORAGE BAG

» 2882165

GENERAL XP 1000/4 '20-26  
GENERAL 1000/4 '16-26

## FRONT HOOD RACK

» 2889157

GENERAL XP 1000/4 '20-26  
GENERAL 1000/4 '16-26

Not compatible with 2026 XP 1000 Premium/Ultimate trims

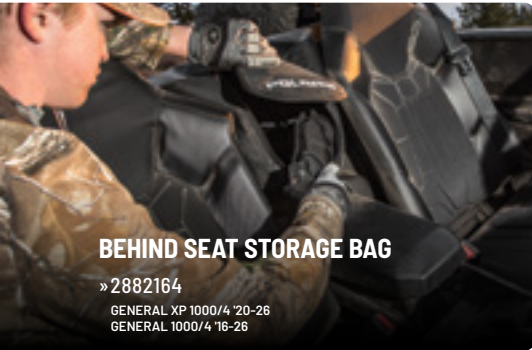

## **K** CARGO BOX

» 2881527

GENERAL XP 1000/4 '20-26  
GENERAL 1000/4 '16-26

Includes all mounting hardware for secure installation

## **K** D-RINGS

TOP SELLER

» 2881545

GENERAL XP 1000/4 '20-26  
GENERAL 1000/4 '16-26



## FIRE EXTINGUISHER HOLDER

» 2882158

GENERAL XP 1000/4 '20-26  
GENERAL 1000/4 '16-26

Fits most 3.25" fire extinguishers (not included)



## **KOLPIN** OUTDOORS

### OVERBED CARGO RACK

- Integrated chainsaw carrying location, bottle opener and tie-down slots
- 7" of clearance above the bed rail to fit gear under rack
- Durable steel and powder-coated finish

» RACK • 53450

Mounting Kit (53504) required, sold separately

» MOUNT • 53504

GENERAL XP 1000/4 '20-26  
GENERAL 1000/4 '16-26



## **KOLPIN** OUTDOORS

### DIAMOND PLATE ALUMINUM BEDSIDE SADDLE BOX

- Lockable stainless steel latch
- Gasketed lid to minimize dust & water
- Integrated mounting holes for quick mount/removal to vehicle bed side
- Durable 15-gauge diamond plate aluminum

» BOX • 53475

Mounting Kit (98510) required, sold separately

» MOUNT (2 REQUIRED) • 98510

GENERAL XP 1000/4 '20-26  
GENERAL 1000/4 '16-26



## **KOLPIN** OUTDOORS

### DIAMOND PLATE ALUMINUM BED BOX

- Lockable stainless steel latches accessible from driver & passenger sides
- Gasketed lid to minimize dust & water
- Durable 15-gauge diamond plate aluminum

» BOX • 53472

Mounting Kit (53504) required, sold separately

» MOUNT • 53504

GENERAL XP 1000/4 '20-26  
GENERAL 1000/4 '16-26



# CAB COMFORT



**TOP SELLER**  
**8-VENT HEATER AND DEFROST SYSTEM**

» 2891326

GENERAL XP 1000/4 '20-26  
 GENERAL 1000/4 '16-26

Not Compatible with Rockford Fosgate® Stage 4 Audio Kits

If subwoofer is installed and adding Heater Kit (2881316), subwoofer must be removed and amp relocation bracket (2885112) must be installed.



**TOP SELLER**  
**GLASS WINDSHIELD WIPER AND WASHER SYSTEM**

» 2881090

GENERAL XP 1000/4 '20-26  
 GENERAL 1000/4 '16-26

SEE P. 18 FOR  
**WINDSHIELDS**



**CONVEX REARVIEW MIRROR**

» 2881540

GENERAL XP 1000/4 '20-26  
 GENERAL 1000/4 '16-26



**SIDE VIEW MIRRORS**

- Mounts directly to ROPS
- Fully adjustable and can fold in to prevent being struck

» 2889243

GENERAL XP 1000/4 '20-26  
 GENERAL 1000/4 '16-26

Not compatible with accessory doors



**HORN KIT**

» 2890589

GENERAL XP 1000/4 '20-26  
 GENERAL 1000/4 '16-26



**FLOOR MATS**

» 2881934

GENERAL XP 1000/4 '20-26  
 GENERAL 1000/4 '16-26

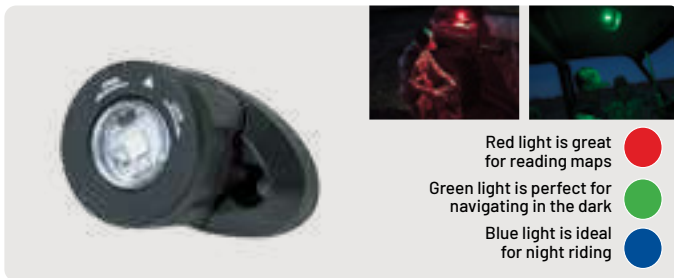

- Red light is great for reading maps
- Green light is perfect for navigating in the dark
- Blue light is ideal for night riding

**MULTI-FUNCTION CAB LIGHT**

- LED dome light provides white, red, green and blue lighting options
- Removable to use as flashlight, battery-operated, recharges when vehicle is on

» 2884047

GENERAL XP 1000/4 '20-26  
 GENERAL 1000/4 '19-26

ELECTRICAL INSTALLS MADE EASY WITH  
**PLUG & PLAY**



- To install accessories, simply plug the harness into the Polaris PULSE bar
- No need to remove nuts and stack wire terminals like a three-post terminal setup
- By plugging in your accessories, a secure connection is guaranteed every time

**TOP SELLER**  
**POLARIS PULSE LED LIGHT BAR HARNESS**

- Required to easily add electric components

» 2883785

GENERAL XP 1000/4 '20-26  
 GENERAL 1000/4 '19-26

# WINCHES

TESTED 1,200+  
PULLS AT MAX LOAD

OPERATES FULLY  
SUBMERGED

BUILT TO WITHSTAND  
-20°F TEMPERATURES

MILITARY  
TESTED & APPROVED



## FEATURES & BENEFITS

### PRO SERIES

BEST FOR PLOWING, HEAVY-DUTY OUTDOOR  
CHORES & TRAIL RIDING

BEST FOR THE CASUAL  
OFF-ROAD RIDER

ALL POLARIS ENGINEERED  
WINCHES COME WITH:



WARRANTY

- ✓ INTEGRATED WIRING, MOUNT, PREASSEMBLED
- ✓ HOOK WITH STRAP
- ✓ CUT STEEL GEARS & SEALED DRIVETRAIN
- ✓ SEALED PERMANENT MAGNET MOTOR

#### RAPID ROPE RECOVERY

5x  
FASTER

Retrieve cable 5x as fast as standard mode on other Polaris winches. Get back to riding or complete your task quicker.

1. Set winch dial to N (Neutral) to manually pull the rope out and secure the hook to your anchor point
2. Set winch dial to L (Low) for maximum pulling power while winching your load
3. Set winch dial to H (High) for retrieving the rope 5x faster with Rapid Rope Recovery



NOT AVAILABLE

#### AUTO STOP TECHNOLOGY

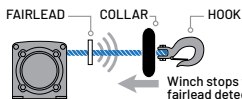

Auto Stop technology protects and extends the life of your winch by automatically stopping the winch at the end of pull to prevent over-spooling. While plowing, it prevents the plow frame from bending by stopping the winch once the plow has been lifted.



ADD AUTO STOP UPGRADE

2881288

SYNTHETIC ROPE REQUIRED



#### PREMIUM SYNTHETIC ROPE



With its lightweight, yet extremely strong, design and superior flexibility, this 50' long synthetic rope is easy to handle and can stand up to any tough job.



ADD SYNTHETIC ROPE

2879187



#### WIRELESS REMOTE



This convenient remote operates your Polaris winch wirelessly from within 50' of the vehicle. Operate your winch safely outside your vehicle while on the job site or trails.



ADD WIRELESS REMOTE

2881287



MODEL

4,500 LB

4,500 LB

GENERAL XP 1000/4 '20-26  
GENERAL 1000/4 '19-26

2891730

TOP SELLER  
2891729

# PLOWS & TRACKS

## PLOW SYSTEMS (WINCH REQUIRED, SOLD SEPARATELY)

Choose a Pro Series Plow System, designed to help you get the most out of your GENERAL during snowy months. Select a system based on your plowing needs with premium add-ons including a hydraulic lift system or additional plow accessories.

### PRO SERIES PLOW SYSTEM WITH HYDRAULICS

System includes:

- Mount (2881763)
- Frame (2880260)
- 72" Steel Plow (2890335)
- Hydraulic Angle (2889052)
- Hydraulic Controller (2883391)
- Plow Markers (2872726)
- Plow Deflector (2858541)

» 3880014

GENERAL XP 1000/4 '20-26  
GENERAL 1000/4 '16-26

Requires lift method:  
See winches below.

### PRO SERIES PLOW SYSTEM

System includes:

- Mount (2881763)
- Frame (2880260)
- 66" Poly Plow (2880269)

» 3880015

GENERAL XP 1000/4 '20-26  
GENERAL 1000/4 '16-26

Requires lift method:  
See winches and hydraulic lift options below.

### PLOW SYSTEM

System includes:

- Mount (2883256)
- Frame (2882927)
- 72" Steel Plow (2890335)

» 3880016

GENERAL XP 1000/4 '20-26  
GENERAL 1000/4 '16-26

Requires lift method:  
See winches and hydraulic lift options below.

CHOOSE A PLOW SYSTEM

## PRO SERIES PLOW SYSTEM

72" or 66" blades

Choice of poly or steel

Manual angle system standard



66" POLY BLADE  
BEST FOR CORROSION RESISTANCE



72" STEEL BLADE  
BEST FOR BIG JOBS YEAR AFTER YEAR

CREATE YOUR PLOW SYSTEM	STEP 1 SELECT A MOUNT	STEP 2 SELECT A FRAME	STEP 3 SELECT A LIFT METHOD	STEP 4 SELECT A BLADE	STEP 5 SELECT ACCESSORIES
<b>GENERAL XP 1000/4 '20-26</b>  <b>GENERAL 1000/4 '16-26</b>	2881763	<b>TOP SELLER</b> 2880260	<b>Pro Series 4,500 LB Winch</b> 2891730 <small>GENERAL XP 1000/4 '20-26 GENERAL 1000/4 '16-26</small>  <b>Hydraulic Plow Angle</b> 2889052 <small>GENERAL 1000/4 '16-18</small>  <b>Hydraulic Plow Controller</b> 2883391 <small>GENERAL XP 1000/4 '20-26 GENERAL 1000/4 '16-26</small>	<b>TOP SELLER</b> <b>72" Steel</b> 2890335  <b>Pro Series 66" Poly</b> 2880269  <b>TOP SELLER</b> <b>66" Steel</b> 2890336	<b>72" Blade Snow Deflector</b> 2858541 <b>72" Heavy Duty Wear Bar</b> 2879875 <b>72" Wear Bar</b> 2204976 <b>66" Blade Snow Deflector</b> 2879866 <b>66" Heavy Duty Wear Bar</b> 2879868 <b>66" Wear Bar</b> 2879867 <b>Plow Markers</b> 2872726 <b>66" Blade Plow Shoe</b> 2208864 <b>Shear Pin</b> 2205527 <b>Replacement T Shear Pin</b> 2204829 <b>Pro Series Plow Extension</b> 2880267 <b>Heavy Duty Deflector</b> 2884160

## PLOW SYSTEM

66" blades

Choice of poly or steel

Manual angle system standard

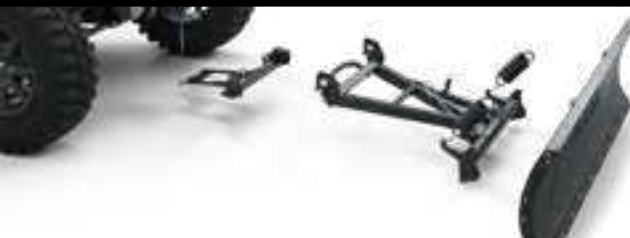

66" POLY BLADE  
BEST FOR CORROSION RESISTANCE



66" STEEL BLADE  
BEST FOR BIG JOBS YEAR AFTER YEAR

Choose a steel blade for longevity and increased rigidity or a lightweight non-stick, poly blade that's easier on plowing surfaces.

CREATE YOUR PLOW SYSTEM	STEP 1 SELECT A MOUNT	STEP 2 SELECT A FRAME	STEP 3 SELECT A LIFT METHOD	STEP 4 SELECT A BLADE	STEP 5 SELECT ACCESSORIES
<b>GENERAL XP 1000/4 '20-26</b>  <b>GENERAL 1000/4 '16-26</b>	2883256	2889307	<b>4,500 LB Winch</b> 2891729 <small>GENERAL XP 1000/4 '20-26 GENERAL 1000/4 '16-26</small>	<b>Pro Series 66" Poly</b> 2880269  <b>TOP SELLER</b> <b>66" Steel</b> 2890336	<b>66" Blade Snow Deflector</b> 2879866 <b>66" Heavy Duty Wear Bar</b> 2879868 <b>66" Wear Bar</b> 2879867 <b>Plow Markers</b> 2872726 <b>66" Plow Shoe</b> 2208864 <b>Shear Pin</b> 2205527 <b>Replacement T Shear Pin</b> 2204829

### PROSPECTOR PRO TRACK MOUNTS

• Install in place of tires and wheels. Tracks sold separately.

» 2880649

GENERAL 1000/4 '16-26

» 2885117

GENERAL XP 1000/4 '20-26

### PROSPECTOR PRO 2.0 TRACK SYSTEM

» 2889487

GENERAL 1000/4 '16-26  
GENERAL XP 1000/4 '20-26

If using Pro Series Plow System, Pro Series Plow Extension is required (2880267)



ACCESSORIES

WINDSHIELDS & REAR WINDOWS

DOORS

ROOFS & PROTECTION

STORAGE & CAB COMFORT

WINCHES, PLOWS & TRACKS

LIGHTING

CONNECTED TECHNOLOGY & AUDIO

HUNT & COOLERS

WHEELS & TIRES & TRAILERING

BUILD A PLOW SYSTEM



# RIGID

**POLARIS PARTNER  
ADVANTAGES**

**MOUNTS PERFECTLY**  
Designed for your Polaris Engineered bumper, roof or other mounting point

**ADVANCED  
TECH**

RIGID® lights are driven by Aluminum PCB Smart Boards®, 6063-T5 aircraft aluminum extruded housings and Tiger Drylac® UV protection polyester powdercoating.

**EXCLUSIVE  
OPTICS**

RIGID® invests heavily in optical science and has patented multiple optics and optics systems, maximizing light output and efficiency.

**RIGID® LIMITED  
LIFETIME WARRANTY**

If you own a RIGID® light and it breaks, we will replace or repair it for life.\*



LIGHT BAR TYPES



**SR-SERIES PRO**

Sleek, powerful, low-profile (under 2" tall). Lights extreme distances with low energy usage.

Available in 10" & 32"



**D-SERIES PRO**

Compact to fit almost anywhere with high output and low energy usage.

Available in Driving, Flood & Spot

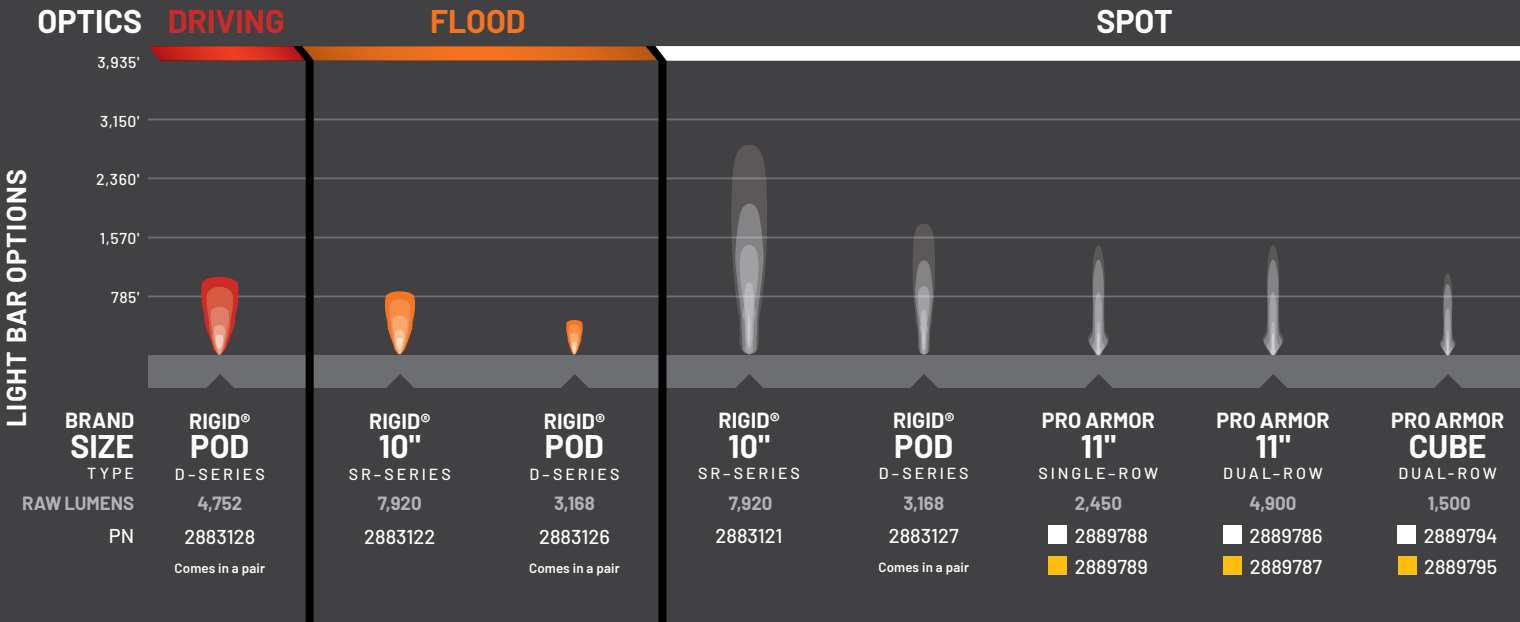

**BUILD YOUR VISION**

Consider the optics, angle & how you will use your vehicle to choose the right light or set of lights.

OPTICS LIGHT ANGLE	ACCENT	DRIVING (45°)	FLOOD (25°)	SPOT (10°)	COMBO (25°/10°)
DRIVING SPEED	All	Slow to medium	Slow to medium	High	All
BEAM	Diffused glow	Extra-wide	Wide/shorter	Concentrated/long	Inner spot & outer flood
RECOMMENDED MOUNTING	Low/wheel well	All points	Low/rear	High points	All points
TERRAIN & RIDING STYLE	Added style & personalization in any terrain	All riding & utility	Wide-open terrain or trails & utility	Trail & tight conditions	All riding & utility

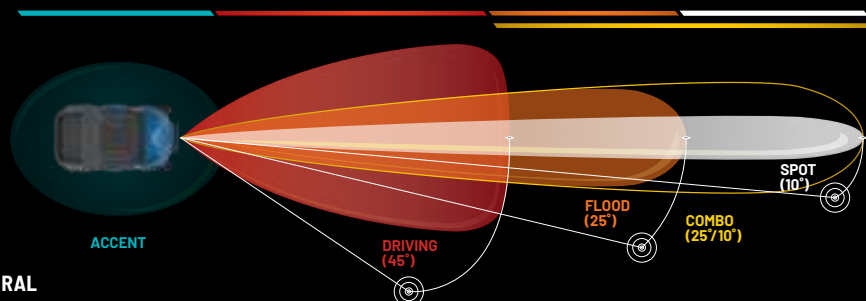

## MAX PERFORMANCE

Validated to work as hard as your machine does

## DOESN'T OVERTAX

Trust it to work when you need it to

# PRO ARMOR®



### RUGGED CONSTRUCTION

Pro Armor lights are designed to be big and beefy with an aggressive style all their own, and housed in IP67 marine-grade rated UV polyester powdercoating.

### MASSIVELY BRIGHT

Pro Armor builds bright lights designed for any riding experience. All that power is directed through heat dissipating aluminum for streamlined heat management.



#### DUAL-ROW LED

The most spread and farthest illumination downrange. Easy to mount.

Available in 11" & 31"



#### SINGLE-ROW LED

Powerful, compact, low-profile light bars with sleek look.

Available in 11", 20", 33" & 40"



#### CUBE LED

Small size allows mounting in strategic locations for added lighting.

Available in Spot

### COMBO

### OPTICS



1,200 m  
960 m  
720 m  
480 m  
240 m

**RIGID® 32"**  
SR-SERIES  
20,064  
2884299

**RIGID® 10"**  
SR-SERIES  
7,920  
2883123

**PRO ARMOR 40"**  
SINGLE-ROW  
7,600  
2889793

**PRO ARMOR 33"**  
SINGLE-ROW  
7,500  
2889791

**PRO ARMOR 31"**  
DUAL-ROW  
13,500  
2889790

**PRO ARMOR 20"**  
SINGLE-ROW  
4,700  
2889792

**BRAND SIZE**  
TYPE  
RAW LUMENS  
PN

### ADD A HARNESS TO MOUNT YOUR LIGHTS

MODEL	LIGHT BAR SET-UPS	
	1 LIGHT IN 1 LOCATION ON 1 SWITCH	2 LIGHTS IN 2 LOCATIONS ON 1 SWITCH
2019-2026 ALL MODELS	POLARIS PULSE LED LIGHT BAR HARNESS 2883785 LIGHT BAR EXTENSION HARNESS 2883854	POLARIS PULSE LED LIGHT BAR HARNESS 2883785 Y-HARNESS 2879860 LIGHT BAR EXTENSION HARNESS 2883854



#### LIGHT BAR MOUNT

- Optional cast mount for added style
  - Compatible with all Pro Armor light bars
- » 2890053

⚠ No battery connection cables required on any GENERAL 1000.

All RIGID® and Pro Armor lights are Polaris PULSE ready.

\* If RIGID® determines, in its sole discretion, that your product is defective in material or workmanship, RIGID® will honor your warranty claim. In some cases the product will be replaced, depending on the specific timeframe of the purchase. If the product is repaired, all parts, labor and return shipping may be covered by RIGID®.

SHOP & VERIFY VEHICLE FITMENT AT  
[POLARIS.COM/SHOPGENERAL](http://POLARIS.COM/SHOPGENERAL)

ACCESSORIES

WINDSHIELDS & REAR WINDOWS

DOORS

ROOFS & PROTECTION

STORAGE & CAB COMFORT

WINCHES, PLOW & TRACKS

LIGHTING

CONNECTED TECHNOLOGY & AUDIO

HUNT & COOLERS

WHEELS & TIRES & TRAILERING

# CONNECTED TECHNOLOGY

## OFF GRID, BUT NEVER OFF THE MAP.

### POLARIS RIDECOMMAND

#### PLAN YOUR RIDE

Plan an epic ride with stops along the way and ensure you're on a marked trail with Snap-to-Trail technology. Later, share your route with friends so you can hit the trails together.

#### FOLLOW THE GROUP

With Group Ride, you can ride at your own speed and keep fellow riders in sight on your map screen, even if you get split up. Because rides are meant to be shared.

#### JOIN THE COMMUNITY

Discover new destinations and get inspired by checking out other rides or events in your area. You can even share your own rides for others to enjoy.

#### DISCOVER NEW TRAILS

With over 1,300,000 miles of trails available offline, you'll have the confidence to explore further, whether you have cellular coverage or not.

#### 7" DISPLAY POWERED BY RIDE COMMAND

Bright, glove-compatible touchscreen visible in all conditions.

**GPS Navigation & Pre-Loaded Maps**  
Available offline on the in-dash display so you know where you are.

**Route Planning**  
Add points of interest and waypoints to make the most of your off-road adventure.

**Group Ride; Patented Technology**  
"Follow the Leader" lets you set and follow the group leader on your display. Group Ride Messaging lets you send messages to your group with or without a cellular signal.

**Camera Integration**  
Navigate with full view of your surroundings. Use the integrated rear camera to see others behind you while riding.

**Personalized Audio Experience**  
Seamlessly pair to your display via Bluetooth® to wirelessly stream music and stay connected with call and text alerts.

**Configurable Gauges**  
Customize your ride experience with elevation, travel direction, fuel level and more to create relevant screens for you.

#### 7" DISPLAY MOUNT KIT

- Mount the display seamlessly into the dash for perfect fit and finish
- Comes with required wiring harnesses and accessory components
- Includes front and rear camera, V2V Group Ride technology and GPS antenna

» 2889338

GENERAL XP 1000/4 '20-26  
GENERAL 1000/4 '20-26

When replacing Factory In-Dash PMX-P2 Audio the following is required: EITHER Amp (2414533) and Relocation Kit (2885112), both required and sold separately -OR- Stage 2 & 3 Audio Kit for RIDE COMMAND (2885163), sold separately.

#### AMP RELOCATION BRACKET

- Used to mount audio amplifier for front and rear speakers when subwoofer is removed
- Required to install a heater on a vehicle with RIDE COMMAND and audio

» 2885112

GENERAL XP 1000/4 '20-21  
GENERAL 1000/4 '20-21

» 2884072

GENERAL XP 1000/4 '20-26  
GENERAL 1000/4 '19-26

LEARN MORE & DOWNLOAD THE POLARIS APP AT  
[RIDECOMMAND.POLARIS.COM](https://RIDECOMMAND.POLARIS.COM)





# VOYAGER<sub>PRO</sub>

## ADD ANY VEHICLE TO YOUR POLARIS GROUP RIDES

The Trail Tech Voyager Pro GPS seamlessly connects with Polaris 7" Displays and is compatible with RIDE COMMAND technology.

Join the group ride.

## THE CONNECTED RIDER'S GPS

Featuring Polaris Group Ride compatibility, custom maps, Bluetooth®, a 4" color touchscreen and full vehicle integration with gauges.

Model-specific kits available for all UTV, ATV, snow and motorcycle brands.

### VOYAGER PRO KIT, UTV

Bright, 4" touchscreen visible in all conditions.

#### Buddy Tracking

Track up to 20 group members no matter what type of vehicle they are riding.

» 922-125

AVAILABLE AT YOUR LOCAL DEALER OR ONLINE AT TRAILTECH.NET

#### Pre-Loaded Base Maps

The map screen is enabled with base maps, topography lines, hill shading and select trails. Record or load GPS trails/riding areas and transfer to a PC.

#### Bluetooth® Enabled

Bluetooth® enabled for intercom, phone and media controls. Play songs from your phone or MicroSD card using a Bluetooth® headset, speaker or intercom. Two phones and two headsets can be connected at the same time.

## 4" RIDE COMMAND COMPANION DEVICE

AVAILABLE ON POLARIS.COM AND AT YOUR LOCAL DEALER



# AUDIO

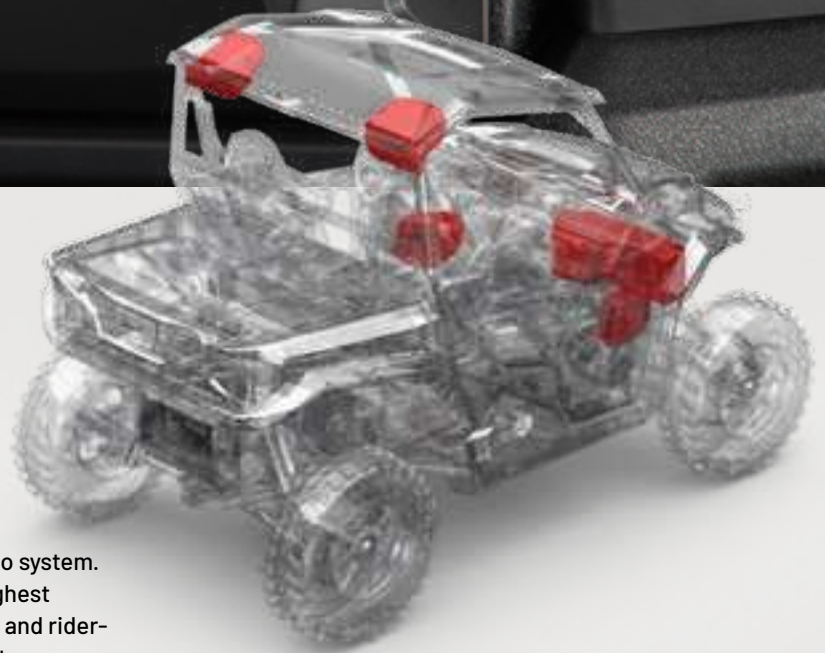

PLUG AND PLAY



ELEMENT READY™



NO LOSS OF CARGO SPACE



BLUETOOTH CAPABLE

An industry first. A true factory installed integrated off-road audio system. Rockford Fosgate® partnered with Polaris to purpose build the highest performing system specifically for the GENERAL platform. Tuned and rider-centric to create a class leading audio experience that is second to none.



**TOP SELLER**  
**STAGE 1 & STAGE 2 AUDIO KIT**  
 PMX-P2 PLUG UNIT & FRONT COAXIAL SPEAKERS & ANTENNA

- 2.7" full color display with AM/FM/WB tuner, Pandora® Control and Bluetooth® Connectivity
- 50 Watt 6.5" front coaxial speakers with enclosures and grilles

» 2884282  
 GENERAL XP 1000/4 '20-26  
 GENERAL 1000/4 '20-26



**REAR COAXIAL SPEAKERS & AMP**

- Two, 50 Watt 6.5" rear coaxial speakers with enclosures and grilles
- 400 Watt 4-channel full range amplifier
- IP67 Rating delivering water resistance and dust protection

» 2885162  
 GENERAL XP 1000/4 '20-26  
 GENERAL 1000/4 '20-26



**TOP SELLER**  
**STAGE 2 & 3 AUDIO KIT FOR RIDE COMMAND**  
 FRONT & REAR COAXIAL SPEAKERS, ANTENNA & AMP

- Two, 50 Watt 6.5" front and rear coaxial speakers with enclosures and grilles
- 400 Watt 4-channel full range amplifier
- IP67 Rating delivering water resistance and dust protection

» 2885163  
 GENERAL XP 1000/4 '20-26  
 GENERAL 1000/4 '20-26  
 Requires 7" Display Powered by RIDE COMMAND (2884072) & 7" Display Mount Kit (2884283), both sold separately.



**TOP SELLER**  
**STAGE 4 UPGRADE POWERED SUBWOOFER**

- 400 Watt 10" subwoofer
- Compatible with Stage 1, Stage 2 & Stage 3 Audio Kits
- » RIDE COMMAND • 2889306\*
- » PMX-P2 • 2889053\*\*

GENERAL XP 1000/4 '20-26  
 GENERAL 1000/4 '16-26  
 Not compatible with Heater Kit (2881316)  
 \*Requires 7" Display Powered by RIDE COMMAND.  
 \*\*Requires PMX-P2 Audio Source.



**ACTIVE BASS CONTROL KNOB**

- Knob to adjust subwoofer output independently of speaker volume
- » 2890427  
 GENERAL XP 1000/4 '20-26  
 GENERAL 1000/4 '16-26  
 Not Compatible with PMX-P2 subwoofer (2889053).



## BUILD YOUR SOUND

HEAD UNIT:

**PMX-P2**

**RIDE COMMAND**

AUDIO:

**STAGE 1 & 2 AUDIO KIT**

**STAGE 3 & 4 UPGRADES**

**STAGE 3 & STAGE 4 RIDE COMMAND AUDIO KIT**

**STAGE 1 & STAGE 2 AUDIO KIT**  
INSTALLED ON XP PREMIUM

**STAGE 3 REAR SPEAKER UPGRADE**  
REAR SPEAKERS,  
AMP + AUDIO BRACKET  
2885162

**RIDE COMMAND + STAGE 3 AUDIO SYSTEM BY ROCKFORD FOSGATE®**

INSTALLED ON XP ULTIMATE

**STAGE 4 UPGRADE SUBWOOFER**  
2889306

If subwoofer is installed and adding Heater Kit (2881316), subwoofer must be removed and amp relocation bracket (2885112) must be installed.

**OPTIONAL SUBWOOFER**

**STAGE 1 & STAGE 2 AUDIO KIT**  
PMX HEAD UNIT,  
FRONT COAXIAL SPEAKERS  
+ ANTENNA  
2884282

**STAGE 4 UPGRADE SUBWOOFER**  
2889053

Not compatible with 8-Vent Heater & Defrost System (2881316)

**7" DISPLAY POWERED BY RIDE COMMAND**

2884072

**7" DISPLAY MOUNT KIT**

2889338

2020-2026 MODELS

**STAGE 2 & 3 AUDIO KIT FOR RIDE COMMAND**

DASH SPEAKERS, AMP + AUDIO BRACKET

2885163

**STAGE 4 UPGRADE SUBWOOFER**

2889306

Not compatible with 8-Vent Heater & Defrost System (2881316)

# HUNT



**KOLPIN**<sup>®</sup>  
OUTDOORS

**PROTECTING YOUR  
ESSENTIAL GEAR SINCE 1943**

## KOLPIN STRONGHOLD CASES & MOUNTS



### KOLPIN STRONGHOLD GUN BOOT XL

- Includes zippered internal liner
- Lockable

» 2882036

GENERAL XP 1000/4 '20-26  
GENERAL 1000/4 '16-26

Auto-Latch Mount (2883970 or 2884106) required,  
sold separately



### KOLPIN STRONGHOLD GUN BOOT L

» 2882426

GENERAL XP 1000/4 '20-26  
GENERAL 1000/4 '16-26

Auto-Latch Mount (2883970 or  
2884106) required, sold separately



### KOLPIN STRONGHOLD AUTO-LATCH MOUNT

» 2884106

GENERAL XP 1000/4 '20-26  
GENERAL 1000/4 '16-26



### KOLPIN STRONGHOLD AUTO-LATCH DOUBLE GUN BOOT MOUNT

» 2883970

GENERAL XP 1000/4 '20-26  
GENERAL 1000/4 '16-26



**STORAGE**



**REAR ADVENTURE RACK**

- Take more gear with integrated molle panels and Lock & Ride installation
- 30 or 60 QT. Polaris NorthStar coolers will still fit in bed with rack installed
- Compatible with (1) Kolpin Stronghold Mount

» 2885113

GENERAL XP 1000/4 '20-26  
GENERAL 1000/4 '16-26



**KOLPIN STRONGHOLD MOUNT**

- Kolpin Stronghold mount for attaching gun boots or other Kolpin Stronghold items to the Rear Adventure Rack

» 2885114

GENERAL XP 1000/4 '20-26  
GENERAL 1000/4 '16-26

**RHINO-RACK® MOUNT**



**GUN MOUNTING BRACKET**

- Bracket used to mount Kolpin Stronghold Gun Boots to Rhino-Rack® systems when paired with Auto-Latch Mount (2884106), sold separately

» 2889327

GENERAL XP 1000/4 '20-26  
GENERAL 1000/4 '16-26

See P. 24 for more Rhino-Rack® products

**KOLPIN RHINO GRIPS** IDEAL FOR BOWS & UNCASSED GUNS



**RHINO GRIP PRO**

» 2884107

GENERAL XP 1000/4 '20-26  
GENERAL 1000/4 '16-26

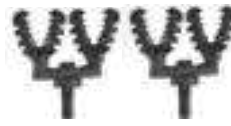

**RHINO GRIP XLR - DOUBLES**

» 2889166

GENERAL XP 1000/4 '20-26  
GENERAL 1000/4 '16-26



**RATCHETING RHINO GRIP**

» 2881575

GENERAL XP 1000/4 '20-26  
GENERAL 1000/4 '16-26



**RHINO GRIP PRO REPLACEMENT RUBBER STRAPS (2)**

» 2884109

GENERAL XP 1000/4 '20-26  
GENERAL 1000/4 '16-26



**RHINO GRIP XLR REPLACEMENT RUBBER STRAPS (2)**

» 2889204

GENERAL XP 1000/4 '20-26  
GENERAL 1000/4 '16-26

# COOLERS



MADE FOR RIDERS.  
BUILT FOR LIFE.

**30, 60 & 105**  
QUART FEATURES



ComfortCarry  
Handles



TravelLock  
System



EasyOut  
Drain System



NoSlip  
Rubber Feet



PolarWall  
Insulation



IceLock  
Seal



## 105 QUART

SAGEBRUSH GREEN • 2890707  
GRAPHITE • 2883426

### ACCESSORIES

WIRE BASKET • 2883648  
DIVIDER (1) • 2883468  
WHEELS • 2883967

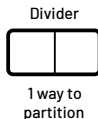

## 60 QUART

SAGEBRUSH GREEN • 2890706  
GRAPHITE • 2883425

### ACCESSORIES

WIRE BASKET • 2882185  
DIVIDERS (2) • 2882184  
SEAT CUSHION • 2882179  
WHEELS • 2882180



## 30 QUART

SAGEBRUSH GREEN • 2890705  
GRAPHITE • 2883424

### ACCESSORIES

WIRE BASKET • 2882438  
DIVIDER (1) • 2882186



## ESSENTIAL ACCESSORIES SO YOUR COOLER WORKS AS HARD AS YOU DO

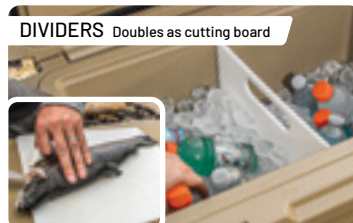
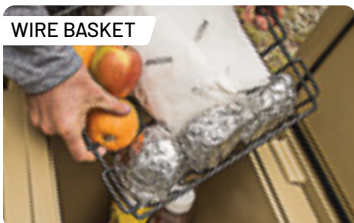



POLARIS NORTHSTAR COOLERS CAN SURVIVE JUST ABOUT ANYTHING - FROM EXTREME HEAT TO A NASTY TUMBLE OFF A VEHICLE.



**15 QUART**

SAGEBRUSH GREEN • 2890704  
GRAPHITE • 2883968



**20 QUART  
SOFT-SIDED COOLER**

GRAPHITE • 2889285



**NEW  
NORTHSTAR 30 QT COOLER STRAP**

• Secures a 30 QT NorthStar Cooler to the bed of the vehicle  
» 2891352

# HOLDS ICE FOR AGES



**BECAUSE JUST ANY COOLER WON'T CUT IT OUT THERE.**

You need something rugged and reliable. A cooler purpose-built to handle the challenges of the off-road—while keeping your provisions on ice for days on end. Because out here, there are no ice machines, and you just left the last one in your dust. So, load it up. Lock it in. And know your NorthStar cooler is staying put—giving you a few extra days of ice time to enjoy the wild.



**TUMBLER**



20 OZ • 2883393

# WHEELS & TIRES



**PRO ARMOR**®

## OFF-ROAD, IT'S ALL ABOUT FREEDOM & CREATING YOUR OWN PATH

As serious riders ourselves, we get it. And everything we design is to get (and keep) you going on the ride of a lifetime. We're for every style of rider looking to go beyond the expected with a ride that will make your story epic.





## WHY CHOOSE PRO ARMOR?

### SUPERIOR PERFORMANCE & DURABILITY

#### LIFELONG PERFORMANCE

- Every tire is designed and constructed with **longevity** in mind
- **3,000+ mile rated** (4,828 kilometers)

#### PREMIUM PROTECTION

- Pro Armor makes tires with **extra protection** exactly where it's needed most – the sidewall
- **Triple-belted sidewalls** keep your tires more resistant so you can keep going  
Many competitors only use double-belted sidewalls

#### TOUGH TIRES

- Higher ply ratings mean added protection
- Pro Armor builds 8 or 10-ply rated tires for **higher puncture-resistance**



# TIRES

Developed and tested with Polaris engineers, ensuring the perfect fit and optimal performance mile after mile.



14"  
15"  
WHEEL

SINGLE-DUROMETER

## PRO ARMOR CRAWLER XR

Premium grip for most terrains, from desert trails to the rocks.

### Why Choose Crawler XR?

Tougher durometer allows for a shorter lug without sacrificing tread life and saves weight. Excels in hard-pack, fast terrain.



14"  
15"  
WHEEL

DUAL-DUROMETER

## PRO ARMOR CRAWLER XG

Unmatched grip for rock crawling with a taller, softer lug.

### Why Choose Crawler XG?

Perfect balance between high-speed performance, durability and flex for traction on slick rocks.



15"  
WHEEL

DUAL-DUROMETER

## PRO ARMOR CRAWLER AT

Handle anything the trail has to throw at you. In the sand or a rocky trail, these tires will stand up to almost anything.

### Why Choose Crawler AT?

Directional lug pattern, more grip and better traction and wider lug spacing for excellent mud clean-out.



15"  
WHEEL

DUAL-DUROMETER

## PRO ARMOR CRAWLER XP

The best in performance, durability and reliability. Designed to tackle the toughest terrain in the most challenging conditions.

### Why Choose Crawler XP?

Superior handling in soft dirt and clay. Extended side lugs for greater traction on rocks and sand.



15"  
WHEEL

DUAL-DUROMETER

## PRO ARMOR ATTACK 2.0

All purpose tread pattern with a 10-ply radial construction provides excellent traction and increased durability.

### Why Choose Attack 2.0?

Tighter lug spacing provides better traction in hard-pack & 10-ply construction provides long-lasting durability.



14"  
15"  
WHEEL

## PRO ARMOR TREKKER

The best balance of on-trail handling and low tire noise.

### Why Choose Trekker?

Ultimate predictability with a quiet ride.





14"  
15"  
WHEEL

DUAL-DUROMETER

PRO ARMOR DUAL-THREAT

Dual compound technology for superior grip and traction.

Why Choose Dual-Threat?

Softer outer lugs for cornering grip and feel; harder inner lugs for longer tread life.



14"  
15"  
WHEEL

PRO ARMOR HARVESTER

Designed for trail & agricultural applications with excellent grip, minimal crop impact and long wear life.

Why Choose Harvester?

Great for unexpected impact and rugged terrain.



14"  
15"  
WHEEL

DUAL-COMPOUND

PRO ARMOR MUD XC

The best tread design that balances aggressive traction in the mud with a smoother ride on the trail.

Why Choose Mud XC?

Perfect mud-trail crossover.



14"  
WHEEL

PRO ARMOR HD-K

One of the strongest Pro Armor tires. Ride through corn stalks, thorns, jagged rocks or whatever else comes your way.

Why Choose HD-K?

Extremely strong tire for long life.

KNOW YOUR TERRAIN



- Tread patterns optimized for extreme traction
- Ideal for both hard pack & loose trail



- Extra deep treads
- Self-cleaning lugs



- Provides traction & durability
- Performs in hard sand, jagged rocks or any extreme terrain



- Triple-belted sidewalls to resist puncture
- Purpose-built, long lasting tread patterns



- Flexible "grippy" tread
- Aggressive side bite



- Handles extreme cold
- Holds shape & provides traction

Pro Armor tires have been developed and tested to ensure the perfect fit, superior durability and optimal performance, mile-after-mile. No matter where you ride - mud, dirt, sand or snow - we've got you covered.



SCAN FOR MORE DETAILS



# WHEELS



BEADLOCK INCLUDED

INNER & OUTER  
BEADLOCK INCLUDED

BEADLOCK REQUIRED

BEADLOCK INCLUDED

## 14" 40-SERIES

### A 4202

FRONT WEIGHT: 12.75 LBS LOAD RATING: 900 LBS OFFSET: +4  
REAR WEIGHT: 13.5 LBS LOAD RATING: 1,300 LBS OFFSET: -9

ACCENT FRONT 14" x 7" 1522544-266  
REAR 14" x 8" 1522545-266

MATTE BLACK FRONT 14" x 7" 1522544-458  
REAR 14" x 8" 1522545-458

### B 4204

FRONT WEIGHT: 13 LBS LOAD RATING: 900 LBS OFFSET: +4  
REAR WEIGHT: 14 LBS LOAD RATING: 1,300 LBS OFFSET: -9

ACCENT FRONT 14" x 7" 1522546-266  
REAR 14" x 8" 1522547-266

MATTE BLACK FRONT 14" x 7" 1522546-458  
REAR 14" x 8" 1522547-458

⊙ Lug Nuts required ⊙ Beadlock sold separately

### C 4205

FRONT WEIGHT: 10.5 LBS LOAD RATING: 900 LBS OFFSET: +4  
REAR WEIGHT: 12.5 LBS LOAD RATING: 1,300 LBS OFFSET: -9

MATTE BLACK FRONT 14" x 7" 1521507-521  
REAR 14" x 8" 1521508-521

LUSTER FRONT 14" x 7" 1521507-410  
REAR 14" x 8" 1521508-410

### D 4301 BEADLOCK

WEIGHT: 16 LBS LOAD RATING: 1,600 LBS OFFSET: +38

ACCENT FRONT/REAR 14" x 7" 1523284

MATTE BLACK FRONT/REAR 14" x 7" 1523283

### E HD DUAL BEADLOCK

WEIGHT: 40 LBS LOAD RATING: 1,600 LBS OFFSET: +38

MATTE BLACK FRONT/REAR 14" x 7" 1524022-458

### F 5201

WEIGHT: 17.1 LBS LOAD RATING: 1,300 LBS OFFSET: +4

MATTE BLACK FRONT/REAR 15" x 7" 1523184-458

### G 5202

WEIGHT: 17.8 LBS LOAD RATING: 1,300 LBS OFFSET: +4

ACCENT FRONT/REAR 15" x 7" 1523102-266

MATTE BLACK FRONT/REAR 15" x 7" 1523102-458

### H 5203 BEADLOCK

WEIGHT: 16 LBS LOAD RATING: 1,300 LBS OFFSET: +38

MATTE BLACK FRONT/REAR 15" x 7" 1522435-458

### I 5301 BEADLOCK

WEIGHT: 17 LBS LOAD RATING: 1,600 LBS OFFSET: +38

ACCENT FRONT/REAR 15" x 7" 1523282

MATTE BLACK FRONT/REAR 15" x 7" 1523266

## BEADLOCK RINGS

### 14" FORGED BEADLOCK RINGS

⊙ Machined 1522244-266  
4203 Beadlock & HD Dual Beadlock

⊙ Matte Black - Replacement 1523146-458  
5301 Beadlock & HD Dual Beadlock

### 15" FORGED BEADLOCK RINGS

⊙ Matte Black - Replacement 1523147-458  
5203 Beadlock

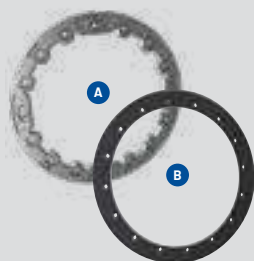

## KNOW YOUR WHEELS

### STEP 1: SELECT YOUR SERIES

4 = 40-SERIES 5 = 50-SERIES

### STEP 2: CHOOSE YOUR LOAD RATING

1 = <800 LBS 2 = 801 - 1,300 LBS 3 = 1,301 - 1,600+ LBS

### STEP 3: PICK YOUR STYLE

OFFSET / BEADLOCK / COLOR

INCREASE OFFSET FROM STOCK = NARROWER STANCE  
DECREASE OFFSET FROM STOCK = WIDER STANCE

# WHEEL & TIRE SETS

14" 40-SERIES	TRAIL		MUD		UTILITY		ROCK	
	DUAL-THREAT 29"	TREKKER 27"	MUD XC		HARVESTER		CRAWLER XR 28"	CRAWLER XG 30"
			27"	29"	27"	28"		
4202 ACCENT	2883148	2890907	2884267	2884260	2882383	2883220	2881343	2881560
4202  MATTE BLACK	2883149	2890905	2884268	2884261	2882384	2883221	2881344	2881561
4204  ACCENT	2883150		2884270	2884263	2882385	2883222	2881355	2881558
4204  MATTE BLACK	2883151		2884271	2884264	2882386	2883223	2881356	2881559
4205  LUSTER							2881371	2881564
4205  MATTE BLACK	2883152		2884269	2884262	2882387	2883224	2881372	2881563
4301 BEADLOCK ACCENT BEADLOCKS PRE-MOUNTED	2883219						2883213	2883211
4301 BEADLOCK MATTE BLACK BEADLOCKS PRE-MOUNTED	2883218						2883212	2883210

## 2 WAYS TO PURCHASE

INDIVIDUAL WHEELS & TIRES  
- OR -  
COMPLETE SETS AS LISTED

SCAN TO BUILD YOUR CUSTOM SET & VERIFY FITMENT

Exclusively at  
Polaris Authorized Dealers or  
[Polaris.com/ProArmorGENERAL](https://Polaris.com/ProArmorGENERAL)

15" 50-SERIES	TRAIL				UTILITY	ROCK			
	ATTACK 2.0		CRAWLER AT	TREKKER	HARVESTER	CRAWLER XG		CRAWLER XP	CRAWLER XR
	28"	30"	30"	30"	30"	28"	30"	30"	30"
5201 ACCENT	2883160	2883169	2889510			2883188	2883179	2889950	2890183
5201 MATTE BLACK	2883159	2883168	2889511			2883187	2883178	2889951	2890184
5202 ACCENT	2883158	2883167	2889512		2885045	2883186	2883177	2889952	2890185
5202 MATTE BLACK	2883157	2883166	2889513	2890916	2885046	2883185	2883176	2889953	2890186
5203 BEADLOCK MATTE BLACK BEADLOCKS SOLD SEPARATELY	2883154	2883163	2889516		2885049	2883182	2883173	2889956	2890187
5301 BEADLOCK ACCENT BEADLOCKS PRE-MOUNTED	2883162	2883171	2889514	2890914	2885047	2883190	2883181	2889954	2890189
5301 BEADLOCK MATTE BLACK BEADLOCKS PRE-MOUNTED	2883161	2883170	2889515	2890913	2885048	2883189	2883180	2889955	2890190

Lug Nuts required

### 12MM x 1.5 SPLINED LUG NUTS



**16 SPLINED LUG NUTS WITH WRENCH ADAPTER**  
»2879332

**4 SPLINED LUG NUTS WITHOUT WRENCH**  
»2879331

**12MM X 1.5 SPLINED LUG WRENCH**  
»2204966

# TIRE SEALANT

24 X 7 COVERAGE | BE PREPARED FOR ANYTHING

## HOW IT WORKS

- 1 Tire sealant remains liquefied inside the tire until a leak develops in the tire or wheel.
- 2 Once a leak occurs, the tire sealant rushes out of the tire and quickly creates a permanent solid plug, maintaining tire pressure so you can continue your ride.



## HOW MUCH DO YOU NEED?

$$\text{TIRE HEIGHT (IN.)} \times \text{TIRE WIDTH (IN.)} / 5 = \text{OUNCES REQUIRED PER TIRE}$$

VISIT [POLARIS.COM/TIRESEALANTCHART](http://POLARIS.COM/TIRESEALANTCHART) TO LEARN MORE

## PREMIUM TIRE SEALANT

- Instantly seals and repairs rim, bead leaks and punctures up to .25" on standard tires and .75" on heavy ply tires
  - Helps seal the tire bead against the wheel
  - Creates permanent repair, helps maintain air pressure for the life of the tire
  - 100% water soluble for easy cleanup
  - Remains fluid and effective in temperatures down to -45° F
  - Will not rust, corrode or pit wheels
  - Easily installed through existing tire valve stem with valve core removed
- » 32 OZ • 2830484
- » 1 GALLON • 2830485
- » 5 GALLONS • 2830486
- » 5 GALLONS PUMP • 2830487
- » 55 GALLONS • 2830489
- » 275 GALLONS • 2830488

# TRAILERING

## RAMPS



### CALIBER® RAMP PRO

- Designed for ATVs and UTVs up to 50" wide
  - Integrated grip glides for ultimate traction
  - Folding sides for easy transportation and storing
- » 52" x 90" • 2884576



### ALUMINUM ARCHED LOADING RAMPS

- Capacity for up to 3,000 LBS, 1,500 LBS per ramp
- » 76" x 12" • 2,000 LB • 2875384
- » 88" x 12" • 3,000 LB • 2875386



### LIGHTWEIGHT TRI-FOLD RAMPS

- Ramp folds up for transport
  - Capacity for up to 1,500 LBS
  - Safety straps included
- » 72" x 51" • 2875385
- » 82" x 51" • 2875860



### FOLDING ALUMINUM ARCHED RAMPS

- Ramp folds up for transport
  - Up to 1,500 LB total capacity, 750 LBS per individual ramp
  - Safety straps included
- » 88" x 12" • 2875387

## COVERS & MISC

### TRAILERABLE COVER BY POLARIS

- » 2-SEAT • 2881841
- » 4-SEAT • 2881787
- GENERAL XP 1000 '20-26
- GENERAL 1000 '16-26
- GENERAL XP 4 1000 '20-26
- GENERAL 4 1000 '17-26



### POLARIS SxS CAMO FIELD COVER

- » 2882160
- GENERAL XP 1000/4 '20-26
- GENERAL 1000/4 '16-26



### OFF-ROAD TOOL KIT BY CRUZTOOLS®

- » 2890429
- GENERAL XP 1000/4 '20-26
- GENERAL 1000/4 '16-26



# CV BOOT REPAIR KIT\*

FIX ON THE GO | TEMPORARY COVERAGE

- A quick trail-side fix to increase trail time
- The flexible and durable boot material expands over a cone tool for CV boot repairs, without disassembling CV axles
- Universal fit – works as a temporary fix for most powersports axles
- All components fit inside the cone, and a cover is provided for compact durable storage
- Easily fits in a cargo box, attached to the roll cage, in the glovebox or many other storage locations



Items shown are contained inside cone

## UTV CV BOOT REPAIR KIT

Kit includes the following items:

- (1) Expandable XL CV Boot
  - (1) Reusable Cone Tool
  - (2) CV Boot Clamps
  - (1) Tube of Silicone Lube
  - (1) Grease Packet
  - (1) Cone Cover
- »2830526

## UTV TRAIL BOOT ONLY

»2830527

## ATV

- » CV REPAIR KIT 2830528
- » TRAIL BOOT ONLY 2830529

SEE HOW THE CV BOOT REPAIR KIT WORKS AT [POLARIS.COM/MAINTENANCE-VIDEOS](http://POLARIS.COM/MAINTENANCE-VIDEOS)



## HOW TO INSTALL

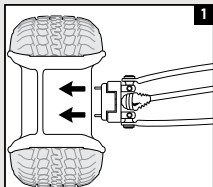

Remove wheel and axle nut.

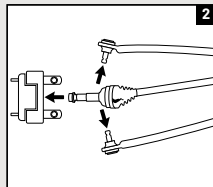

Remove brake caliper, hub, tie rod and upper and lower ball joints.

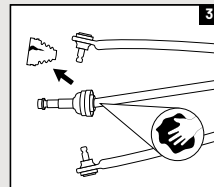

Remove old boot and clean joint.

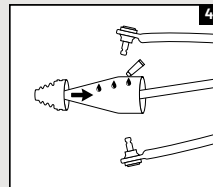

Spread silicone lube on entire cone tool. Slide boot over cone tool, large end first. See package for outer boot instructions.

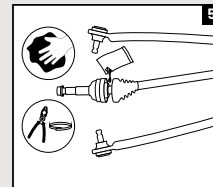

Empty the bag of grease into the CV joint/boot, clean sealing points and install clamps.

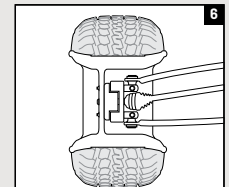

Reassemble tie rod, ball joints, brake caliper, axle nut, tire and wheel.

Refer to your service manual for further instructions and torque specifications.  
\*Designed for temporary CV boot repair. Purchase the OEM CV Boot for a permanent repair.

## HITCHES



### HITCH WITH 2" BALL

- 3:1 Hitch: ball, hook and pin design
  - Rust resistant steel with powdercoat finish
  - Removable ball, 5/8" pin and clip
- » 2" x 2" RECEIVER • 2830522  
» 1 1/4" x 1 1/4" RECEIVER • 2830523



### 1 7/8" BALL

- 1 7/8" replacement ball for hitch
  - Designed to work with 3:1 Hitch
- »2830524



### RECEIVER HITCH

- » 2" RECEIVER TONGUE 2875320



### TRAILER BALL 3/4" SHANK

- » 1 7/8" BALL • 2877602
- » 2" BALL • 2877603

## STRAPS & ROPES



### RECOVERY STRAP

- 2" x 30'
  - 18,000 LB maximum load / 9,000 LB maximum vehicle weight
  - Comes with carry bag
- »2884033



### RATCHET STRAP

- 1.5" x 15' straps, 2 pack
  - Heavy duty webbing
  - 5,500 LB maximum load, 1,833 LB working load
- »2884031



### RATCHET STRAP

- 2" x 20'
  - Heavy duty webbing, floating D-rings, double J-hooks
  - 10,000 LB maximum load, 3,300 LB working load
- »2884032



### SHOCK STRAPS

- 1.5" 3,000 LB breaking strength
  - Keeps tension on tie-down straps to secure load, 2 pack
- » 1.5" x 15' • 2883296  
» 1.5" x 7' • 2883295

ACCESSORIES

WINDSHIELDS & REAR WINDOWS

DOORS

ROOTS & PROTECTION

STORAGE & CAB COMFORT

WINCHES, PLOW & TRACKS

LIGHTING

CONNECTED TECHNOLOGY & AUDIO

HUNT & COOLERS

WHEELS & TIRES & TRAILERING

# MAINTENANCE PARTS & FLUIDS

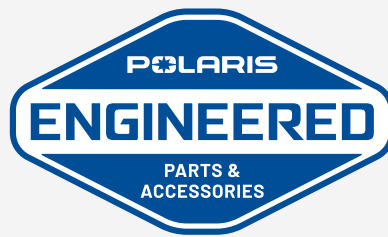

## POLARIS ENGINEERED PARTS AND OIL

have been validated and tested extensively, specifically for your vehicle. In order to maintain the peak performance of your Polaris vehicle only use official Polaris Engineered parts and oil.



We're taking the passion of our riders, workers and outdoor enthusiasts to the next level with HD Parts. These Heavy Duty parts are engineered for riders who want greater durability and enhanced performance. HD Parts are designed and tested to handle greater wear and tear under all weather conditions.



### A DRIVE BELTS

- » 3211196  
GENERAL 1000
- » 3211180  
GENERAL XP 1000
- » **HD** • 3212359  
GENERAL 1000 / XP 1000



### B BRAKE PADS

- » FRONT • 2205949
- » **HD** • FRONT • 2208933
- » REAR • 2203318
- » **HD** • REAR • 2208936



### C OIL FILTER

- » 2540086
- » **HD** • 2522498



### D BATTERY

- » 4014132-P
- » **HD** • 4081855



### E AIR FILTER

- » 7082115



### F SPARK PLUG

- » 3022662

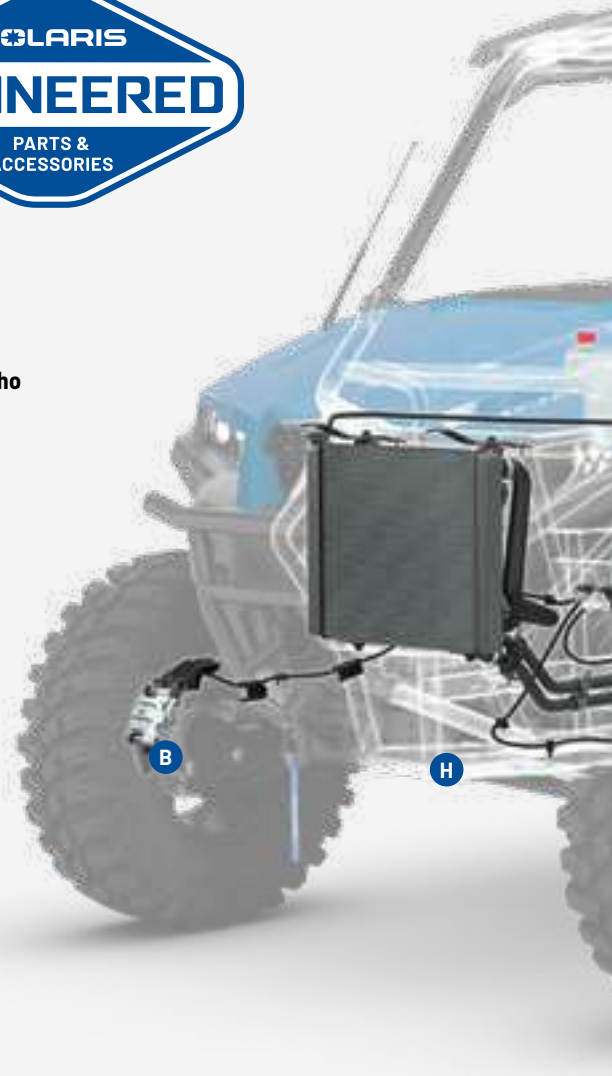

## LOOKING FOR MORE SERVICE PARTS?

See P. 55 to learn how to find parts for your model.

# MAINTENANCE SCHEDULE\*

## BREAK-IN MAINTENANCE

FIRST 25 HRS / 1 MONTH | 250 MI / 400 KM

**ENGINE OIL & OIL FILTER**  
CHANGE

**AIR FILTER**  
INSPECT  
REPLACE AS NEEDED

**FRONT GEARCASE**  
INSPECT FLUID  
REPLACE AS NEEDED

**GENERAL LUBRICATION**  
ALL FITTINGS, PIVOTS, CABLES, ETC.

## 6 MONTHS

50 HRS | 500 MI / 800 KM

**FRONT GEARCASE**  
INSPECT FLUID  
REPLACE AS NEEDED

**DRIVE BELT**  
INSPECT & ADJUST  
REPLACE AS NEEDED

**GENERAL LUBRICATION**  
ALL FITTINGS, PIVOTS, CABLES, ETC.

## 12 MONTHS

100 HRS | 1,000 MI / 1,600 KM

**ENGINE OIL & OIL FILTER**  
CHANGE

**TRANSMISSION & GEARCASE**  
CHANGE FLUIDS

**DRIVE BELT**  
INSPECT & ADJUST  
REPLACE AS NEEDED

**AIR FILTER**  
INSPECT  
REPLACE AS NEEDED

## 18 MONTHS

150 HRS | 1,500 MI / 2,400 KM

**ENGINE OIL & OIL FILTER**  
CHANGE

**BATTERY**  
TEST & CLEAN  
REPLACE AS NEEDED

**DRIVE BELT**  
INSPECT & ADJUST  
REPLACE AS NEEDED

**FRONT GEARCASE**  
INSPECT FLUID  
REPLACE AS NEEDED

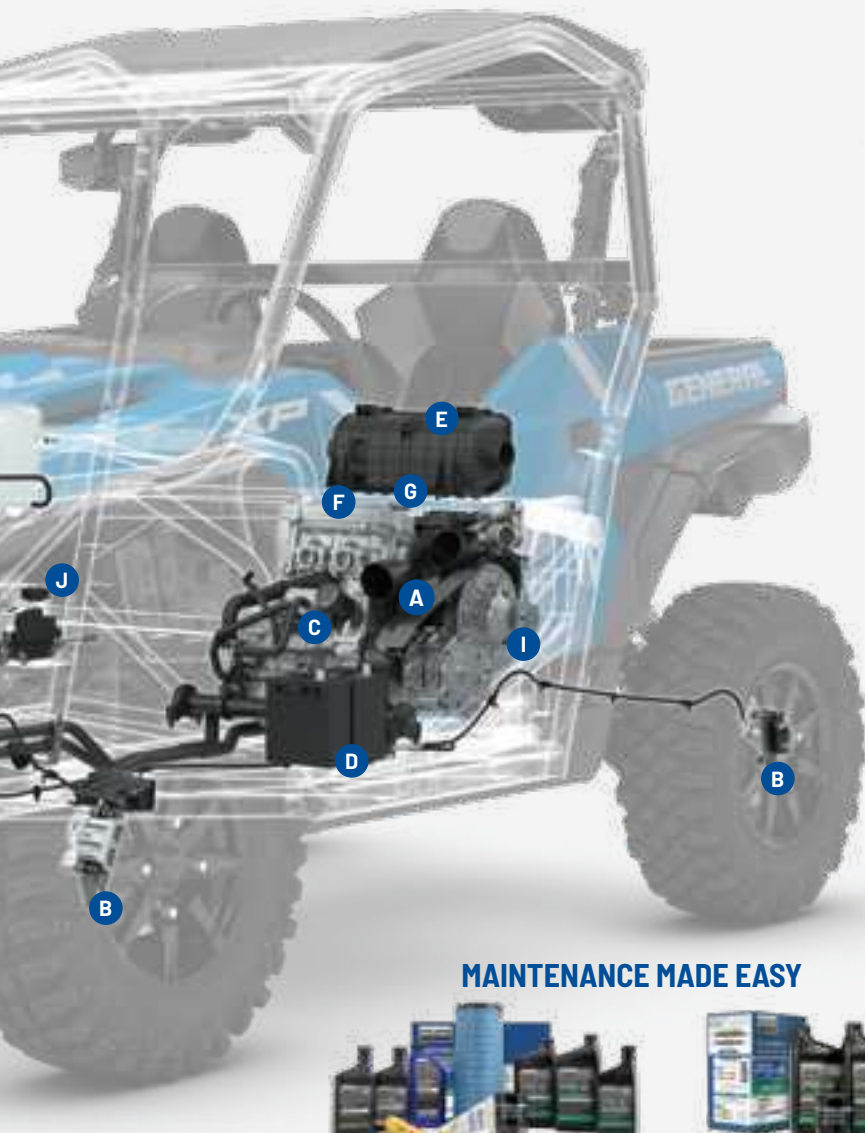

**G**  
**ENGINE OIL** P. 50  
 »PS-4 • 1QT • 2876244  
 »PS-4 • 1GAL. • 2876245  
 »PS-4 EXTREME • 1QT • 2889395  
 »PS-4 EXTREME • 1GAL. • 2889396



**H**  
**DEMAND DRIVE FLUID**  
 For front gearcase  
 »1QT • 2877922  
 »2.5 GAL. • 2877923



**I**  
**AGL**  
 For transmission  
 »1QT • 2878068  
 »1 GAL. • 2878069  
 »EXTREME • 1QT • 2891028



**J**  
**DOT 4 BRAKE FLUID**  
 »12 OZ • 2872189

**MAINTENANCE MADE EASY**



**ORV MAINTENANCE KIT**  
 Includes Oil Change Kit, Gearcase Fluids, Air Filter, & Spark Plug  
 »2830544



**OIL CHANGE KITS**  
 2.5 QT Engine Oil (oil varies by kit), 1 Oil Filter (2540086) & 1 Drain Plug Washer  
 »PS-4 • 2879323  
 »PS-4 EXTREME • 2890057



**ALL-SEASON GREASE TUBE**  
 »3 OZ • 2871322  
 »14 OZ • 2871423

Claims made based off testing and performance of Polaris HD Parts against standard OEM parts made by Polaris and competitor brands under normal use. For more information regarding Polaris HD parts including vehicle compatibility, installation and maintenance, please contact your authorized Polaris ORV dealer.

**24 MONTHS**

200 HRS | 2,000 MI / 3,200 KM

- ENGINE OIL & OIL FILTER**  
CHANGE
- TRANSMISSION & GEARCASE**  
CHANGE FLUIDS
- BRAKE FLUID**  
REPLACE
- BRAKE PADS**  
INSPECT  
REPLACE AS NEEDED
- SPARK PLUGS**  
INSPECT  
REPLACE AS NEEDED
- AIR FILTER**  
INSPECT  
REPLACE AS NEEDED

**30 MONTHS**

250 HRS | 2,500 MI / 4,000 KM

- ENGINE OIL & OIL FILTER**  
CHANGE
- BATTERY**  
TEST & CLEAN  
REPLACE AS NEEDED
- DRIVE BELT**  
INSPECT & ADJUST  
REPLACE AS NEEDED
- FRONT GEARCASE**  
INSPECT FLUID  
REPLACE AS NEEDED
- GENERAL LUBRICATION**  
ALL FITTINGS, PIVOTS, CABLES, ETC.

**36 MONTHS**

300 HRS | 3,000 MI / 4,800 KM

- ENGINE OIL & OIL FILTER**  
CHANGE
- TRANSMISSION & GEARCASE**  
CHANGE FLUIDS
- AIR FILTER**  
INSPECT  
REPLACE AS NEEDED

**FOR A COMPLETE MAINTENANCE SCHEDULE, CHECK YOUR OWNER'S MANUAL**



\*This is a sample maintenance schedule. Please reference and use your owners manual for full maintenance and vehicle care.

# OIL & LUBRICANTS

Our PS-4 engine oils provide ultimate performance and protection, they're formulated with exclusive additives to keep engines clean from deposit buildup. These powersports-grade full synthetic oils helps maximize power and protect your engine for the long term.

## PS-4 FORMULATIONS BEST PROTECTION, BEST PERFORMANCE



### PS-4 5W-50 FULL-SYNTHETIC OIL

Optimal for ambient operating temperatures of -40° F to 100° F.

1 Quart 2876244    1 Gallon 2876245    16 Gallons 2876247    55 Gallon Drum 2876246    330 Gallon Tote 2878814

### PS-4 0W-50 EXTREME FULL-SYNTHETIC OIL

Optimal for ambient operating temperatures of -45° F to 130° F.

1 Quart 2889395    1 Gallon 2889396    16 Gallons 2889397    55 Gallon Drum 2889398    330 Gallon Tote 2889399

## OIL CHANGE KITS

These convenient kits include everything needed including filter and oil volume per vehicle

PART NUMBER	VEHICLE FITMENT	PART NUMBER
2890882	RANGER XD 1500	2890883
2202166	RANGER 500, RANGER/RZR/SPORTSMAN 570, TWIN 600, TWIN 700, TWIN 800	2890056
2879323	RANGER, GENERAL 900-1000, RZR 900-1000, RS1, POLARIS XPEDITION	2890057
2877473	RANGER/SPORTSMAN 300-500, SPORTSMAN/SCRAMBLER 500/850/1000	2890055
2881696	RZR TURBO (NON PRO R)	2890058
2890880	RZR PRO R	2890881

## POLARIS INVESTS IN EACH OIL AT & ABOVE THESE LEVELS

**12+ DEDICATED  
TEAM MEMBERS**  
FOCUSED ON POLARIS OIL

**18+  
MONTHS**  
DEVELOPMENT & TESTING

**76,000+  
HOURS**  
DYNO TESTING

**2.2/3.5 MILLION+  
MILES/KM**  
FIELD TESTING



#### DOT 4 BRAKE FLUID

A high-quality brake fluid designed for use in Polaris hydraulic brakes.  
» 12 OZ • 2872189



#### SUSPENSION/ U-JOINT GREASE

» 3 OZ • 2871515  
» 14 OZ • 2871551



#### GAS SHOCK OIL

» 1 QT RACING • 2874124  
WALKER EVANS RACING  
REBUILDABLE SHOCKS  
» 1 QT PREMIUM • 2870995  
FOX® REBUILDABLE SHOCKS



#### AGL

Protects transmission components against wear, corrosion, oxidation and foam in transmissions.  
» 1 QT • 2878068  
» 1 GALLON • 2878069  
» EXTREME • 1 QT • 2891028



**POLARIS**  
**EXTREME**  
SYNTHETICS

**PS-4 EXTREME SYNTHETIC 0W-50**

- Our best extreme high and low temp formula, excellent for high temperatures and racing, even at temps of 130°F, plus easier cold starting even below -45°F
- Expect the best in wear protection thanks to premium PAO and ester base stocks combined with a balance of moly and ZDDP additives
- Polaris exclusive clean engine additive system reduces deposits and carbon build-up for peak performance and power

**THE BEST PROTECTION, MAXIMUM PERFORMANCE**

- Powersports grade full synthetics provide long lasting engine protection
- At least 40% improved wear protection compared to all aftermarket oils tested (see engine wear test chart)
- Polaris exclusive clean additive system
- At least 50% less deposits than all aftermarket oils tested (see deposit test chart)
- Cleaner engine with less deposits means consistent maximum power and performance

**WIDEST VISCOSITY FOR ULTIMATE PROTECTION**



**ENGINE WEAR TEST**

LOWER NUMBER = LESS ENGINE COMPONENT WEAR  
LESS WEAR ON PARTS MEANS LONGER ENGINE LIFE

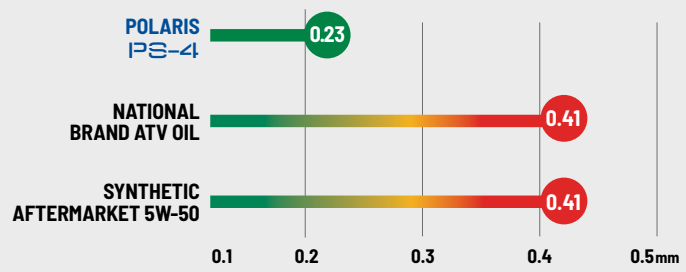

ASTM D4172. In 3rd party testing against 9 competitive products Polaris had 40% or better wear protection compared to all of the tested products. Numbers represent mm of wear scarring measured. Test measures wear at contact points, wear scar is measured for its length and width (in units of mm). Lower wear numbers mean better wear protection and friction reduction.

**DEPOSIT TEST**

LOWER DEPOSITS = MAXIMUM POWER

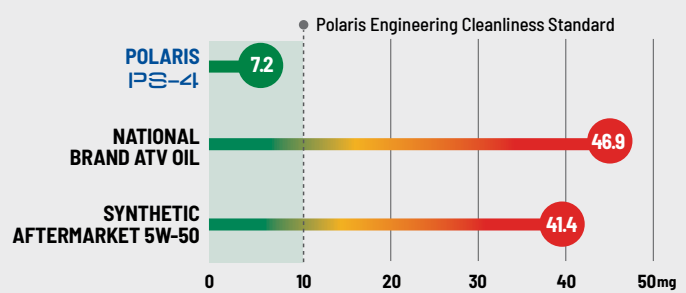

ASTM D6335. In 3rd party testing against 9 competitive products Polaris PS-4 had less than half the deposits compared to the next closest product. No other tested products met Polaris Engineering standards for deposit cleanliness. Test measures mass of deposits in mg in high temp, high stress test cycles. Higher deposits will impact engine power and performance.



**DEMAND DRIVE FLUID**

Proprietary formulation prevents clutch slippage and chatter and reduces component wear and corrosion.  
» 1 QT • 2877922  
» 2.5 GALLONS • 2877923



**ANTI-FREEZE**

Prevent corrosion on metal components, eliminate scaling and maximize cooling system performance.  
» 1 QT • 2880514  
» 1 GALLON • 2880513  
» 55 GALLONS • 2880512



**CARBON CLEAN**

Ultimate fuel and injection system cleaner.  
» 12 OZ • 2881413



**ADVANCED FUEL TREATMENT**

Dual antioxidant formula protects jets and fuel system from gum and varnish.  
» 12 OZ • 2881416

# GARAGE ACCESSORIES



## **BELT CHANGE TOOL KIT**

- Be prepared for whatever the outdoors throws your way
  - Includes everything you need to get back on the move
  - Rolls up to fit easily under seats, in glove boxes or storage bins
  - Does not include Belt
- » 2830611



## **ESSENTIAL KIT**

- Contains Jumper Cables, Portable Trail Tech Air Compressor, Ratchet Strap, Tow Strap, Tire Plug Kit, First Aid, Duct Tape, Electrical Tape, Zip Ties, Rag, and Case
- » 2881207



## **PARTS TRAY CABINET**

- Roller bearing design
- 20.5" W x 16.75" D x 14.75" H
- » PARTS TRAY CABINET W/ 4 DRAWERS • 2830605
- » SQUARE DIVIDERS (24 COMPARTMENTS) • 2830606
- » ADJUSTABLE DIVIDER • 2830607
- » CABINET STAND • 2830608
- » CABINET WITHOUT DRAWERS • 2830609



## **FLEXIBLE CLUTCH COVER TOOL**

- Set includes:
  - (1) 1/4" drive x 11" flexible driver
  - (1) 1/4" Drive double sided socket - 1/4" x 8mm
  - Rubber grip handle and flexible shaft for better leverage
- » 2830572



## **BATTERY OPERATED FLUID TRANSFER PUMP**

- Liquid transfer pumps 5-6 quarts/min suctioning power
  - Powered by two 'D' batteries (not included)
- » 2830513



## **BATTERY OPERATED FLUID TRANSFER PUMP WITH FLOW CONTROL NOZZLE**

- Ideal for quick transfer of fluid, diesel, DEF/Adblue, water & water-based media
  - Handheld flow control nozzle
  - Powered by two 'D' batteries (not included)
- » 2830595



## **FLUID FUNNEL**

- Narrow spout for controlled pouring
  - Designed to prevent overfills
  - Durable for all types of chemical exposure
- » 2830552



## **FLUID SYRINGE**

- Easily add and remove fluid from your vehicle
- » 2830553



## **FLUID CHANGE TRAY**

- 22" x 22" x 11.5"
  - Chemical and heat resistant
  - Holds up to 2 gallons of liquid
- » 2830551



## **FUNNELS**

- Narrow spout for controlled pouring
  - Designed to prevent overfills
  - Durable for all types of chemical exposure
- |                              |                            |                              |
|------------------------------|----------------------------|------------------------------|
| » 1.25 QT<br>BLUE<br>2830574 | » 1.5 QT<br>RED<br>2830575 | » 1.5 QT<br>GREEN<br>2830576 |
|------------------------------|----------------------------|------------------------------|



## **GREASE GUN**

- For 14 oz All-Season & U-Joint
  - Heavy-duty, one-handed pistol grip
  - 5,000 PSI, with a 4" steel extension efficiently lubricates, reduces friction and wear and tear
- » 14 OZ • 2830569



## **GREASE GUN**

- For 3 oz All-Season & U-Joint
  - Tough steel construction
  - Accepts both 6" rigid pip nozzle and 12" 12,000 PSI flex hose
  - Enables easy application of grease
- » 3 OZ • 2871312



### EXTENSION CORDS

- Light-up cords designed for extreme cold and heat
- » HD XD 50' TRIPLE OUTLET 1 $\frac{1}{2}$ " • 2830587
- » 25' SINGLE OUTLET 1 $\frac{1}{2}$ " • 2830588
- » 50' SINGLE OUTLET 1 $\frac{1}{2}$ " • 2830589
- » 2' TRIPLE END 1 $\frac{1}{2}$ " • 2830603
- » 2' ADAPTER 30A TO 20A 1 $\frac{1}{2}$ " • 2830602



### POLARIS SHOP TOWELS

- » 200 CT W/ DISPENSER • 2830402
- » 200 CT REFILL • 2830403
- » 64 CT REFILL • 2830440
- » HEAVY-DUTY SCRUBBER WIPES 90 CT • 2830441



### HANDHELD PUMP SPRAYER

- Half gallon portable sprayer
- Lightweight and easy to use
- » 2830570



### WORK LIGHT - 550 LUMENS

- UV and dual-charging on a 360° rotating swivel
- » 2830584



### PUMP

- Fits 1 and 2.5 gallon bottles
- » 2870465



### OIL CHANGE KIT

- 6.5 QT drain pan, one pint oil funnel with screen, oil filter wrench, 15" x 18" absorbent pads (2), clean up wipe (1), 6 mil nitrile gloves (1 pair), blue interfold shop towels (4)
- » 2830545



### POLARIS MAGNETIC PARTS TRAY

- » 2830432



### POLARIS LED POCKET FLASHLIGHT

- Powerful beam - extends 200'
- Powered by 2 AAA batteries
- 90 lumens, 1 watt, energy efficient light
- » 2830436



### WORK LIGHT - 1000 LUMENS

- Adjustable with magnetic ends
- Battery charge indicator
- » 2830585



### FLEX SPOUT

- Fits all Polaris quart, gallon and 2.5 gallon bottles
- » 2871285



### OIL FILTER WRENCH - 65 MM (2 $\frac{9}{16}$ " ) & 73 MM (2 $\frac{7}{8}$ " )

- 65MM: 14 flute cup size, used with  $\frac{3}{8}$ " square drive
- 73MM: 15 flutes cup size, used with  $\frac{3}{8}$ " square drive
- Works with Polaris Oil Filters 2540086, 2520799, 2521728 and other 14 & 15 flute filters
- » 65 MM (2  $\frac{9}{16}$ " ) • 2830550
- » 73 MM (2  $\frac{7}{8}$ " ) • 2830594
- PRO R



### POLARIS 33" TELESCOPIC MAGNET

- Retrieve fasteners or parts dropped in hard-to-reach places
- 5 LBS of holding strength
- Extends from 6.5" to 33"
- » 2830435



### TRAIL TECH PORTABLE AIR COMPRESSOR

- Handheld air compressor with Li-ion battery
- Programmable PSI pressure settings, LED light and USB phone charger
- » COMPRESSOR • 060-DAP
- » CASE • 060-BAG
- » 15" EXTENDER HOSE • 060-LHS



### WORK LIGHT - 4000 LUMENS

- 90° swivel LED light with magnetic backing
- 16', 14 gauge extension cord cable reel
- » 2830586

# BATTERY CHARGERS



## NOCO GENIUS® BATTERY CHARGER - 1 AMP

- Keep your battery charged
  - Includes Boost Eyelet Cable with X-Connector Adapter (2830546)
  - Includes adapter for vehicle charge port
- » 2830567



## NOCO GENIUS® BATTERY CHARGER - 2 AMP

- Keep your battery charged
  - Includes Boost Eyelet Cable with X-Connector Adapter (2830546)
  - Includes adapter for vehicle charge port
- » 2830568



## NOCO GENIUS® BATTERY CHARGER - 5 AMP, 2 BANK

- Waterproof charger
  - 5 amps per bank for charging any 12v, AGM, lead-acid and/or lithium-ion batteries
- » 2830599



## NOCO GENIUS® BATTERY CHARGER - 10 AMP, 4 BANK

- Waterproof charger
  - 10 amps per bank for charging any 12v, AGM, lead-acid and/or lithium-ion batteries
- » 2830601



## NOCO BOOST® GB40 12V 1000A JUMP STARTER

- Delivers 1,000 amps for jump starting a dead battery in seconds
- » 2830547



## NOCO BOOST® GB70 12V 2000A JUMP STARTER

- Delivers 2,000 amps for jump starting a dead battery in seconds
- » 2830597



## NOCO BOOST® JUMP PACK PROTECTION CASES

- Lightweight, durable and rugged custom exterior
- » GB40 • 2830548  
» GB70 • 2830598

YOUR BATTERY  
**IS READY**  
WHEN YOU ARE

# SERVICE PARTS

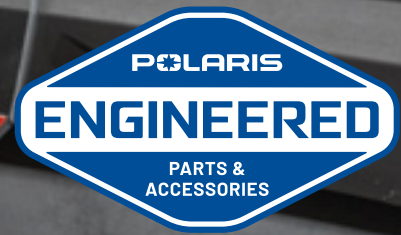

**POLARIS ENGINEERED SERVICE PARTS DELIVER UNMATCHED PERFORMANCE AND FIT FOR YOUR OFF-ROAD VEHICLE.**

All service parts are engineered specifically for your machine. Which means everything is designed, tested and perfected to maximize the life of your ride. Getting Polaris Engineered parts is a decision that pays off in the long run, because there is a long run.

**SHOP FOR SERVICE PARTS ONLINE OR VISIT YOUR POLARIS DEALER.**



## LOOK-UP PARTS ON POLARIS.COM

FOR EASY PARTS IDENTIFICATION, VIEWS OF ASSEMBLIES & MORE!

Visit [Polaris.com/GENERAL](https://www.polaris.com/GENERAL)

Click the "Parts & Accessories" tab

Enter **vehicle year/model** then **select the part**

Clearly see what parts are required and **order**

# HD HEAVY DUTY PARTS

All Polaris parts are developed and tested to help you get the most out of your ride. Now, we're taking the passion of our riders, workers and outdoor enthusiasts to the next level with HD Parts. Polaris HD Parts are built for riders who push their machines to the limit—day after day, season after season. These are the ranchers, construction workers and relentless trail riders who ride in the extreme terrains and environments. From the heat of Texas to the frozen tundra of Northern Canada, and the swamps of Louisiana to the mountains of Wyoming.

LIMITED

WARRANTY

BEARINGS  
BUSHINGS  
DRIVE BELTS

WARRANTY

AXLES  
BATTERIES

WARRANTY

AIR FILTERS  
BRAKE PADS  
OIL FILTERS





## ENGINEERED TO HANDLE **EXTREME CONDITIONS**

We know you push your vehicle to the limit, demanding top performance. HD parts are developed to expand the boundaries of your ride and tackle extreme conditions:

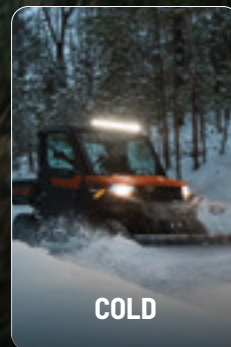



# APPAREL

**FIT FOR ANY ADVENTURE.** For outdoor enthusiasts looking for gear that's purposefully built to stand up to the fun and challenging experiences Polaris vehicles enable. Each piece of apparel and equipment bearing the name Polaris is crafted by outdoor enthusiasts, for outdoor enthusiasts. They are a badge of honor - representing what the Polaris brand stands for - a passion to simply be outside doing what you love.



SCAN TO SHOP  
THE FULL LINEUP OF  
POLARIS APPAREL

# JERSEYS & GLOVES

## THROTTLE JERSEYS

ADULT: S-3XL  
YOUTH: S-XL

- Mesh ventilated panels for maximum airflow
- Elastic sleeves with non-restrictive cuffs

## THROTTLE GLOVES

ADULT: S-3XL  
YOUTH: S-XL

- Adjustable wrist closure for a custom fit
- Silicon finger grips and neoprene knuckle protection



NEW

### OLIVE

Adult | 2866415  
Youth | 2866416

### WHITE/BLUE

Adult | 2865376

### TAN/ORANGE

Adult | 2865377  
Youth | 2865382

### FUCHSIA/GRAY

Adult | 2865379  
Youth | 2865381

### TEAL/LIME

Adult | 2865378

### BLACK

Adult | 2865374

### BLUE

Adult | 2865375  
Youth | 2865380



NEW

### RED

Adult | 2866411

NEW

### OLIVE

Adult | 2866410  
Youth | 2866417

### WHITE/BLUE

Adult | 2865385

### TAN/ORANGE

Adult | 2865386  
Youth | 2865391

### FUCHSIA/GRAY

Adult | 2865388  
Youth | 2865390

### TEAL/LIME

Adult | 2865387

### BLACK

Adult | 2865383

### BLUE

Adult | 2865384  
Youth | 2865389

# HATS & GAITERS



### BLUE

2833138

### LIME

2861952

### CAMO

2861948

### BLACK

2861953

### RED RETRO

2861950

## NECK GAITERS

- Keep the sun off your neck and the dust off your face
- Stretchy and seamless material
- UPF 15-18 for sun protection and moisture-wicking



### ELLIPSE PATCH TRUCKER HAT

NEW Red | 2866468  
Black | 2833500  
Gray | 2833498

Orange | 2833124  
Navy | 2833499  
Cypress | 2864562



### CORE CAP TOP SELLER

Red | 2833123  
Black | 2833495  
Navy | 2833494  
Gray | 2833507



### STAPLE CAP TOP SELLER

NEW Sand | 2866471  
Maroon | 2865516  
Navy | 2833128  
Black | 2833127  
Cypress | 2864568



### SHADOW LOGO CAP

Black | 2865519  
Olive | 2865520

# OUTERWEAR & CASUALWEAR



## SOFTSHELL JACKET 2.0

- |                                   |                        |
|-----------------------------------|------------------------|
| <b>MEN'S   S-3XL</b>              | <b>WOMEN'S   S-3XL</b> |
| <b>NEW</b> Forest Green   2866404 | Black   2865343        |
| Black   2865318                   | Blue   2865344         |
| Rust   2865319                    |                        |
| Blue   2865320                    |                        |



## RANGE WORK JACKET

- |                      |                        |
|----------------------|------------------------|
| <b>MEN'S   S-3XL</b> | <b>WOMEN'S   S-3XL</b> |
| Black   2865321      | Black   2865345        |
| Tan   2865322        | Tan   2865346          |



## RANGE WORK GLOVE

- |                      |
|----------------------|
| <b>MEN'S   S-3XL</b> |
| Black   2865392      |



## UPF HOODIE TEE

- |                      |                           |
|----------------------|---------------------------|
| <b>MEN'S   S-3XL</b> | <b>WOMEN'S   S-3XL</b>    |
| Olive   2865492      | <b>NEW</b> Gray   2866421 |
| Blue   2833072       | Navy   2865494            |
| Gray   2833073       | Teal   2833103            |



## PLAID FLANNEL SHIRT

- |                      |
|----------------------|
| <b>MEN'S   S-3XL</b> |
| Cabernet   2865495   |
| Blue   2864671       |
| Cypress   2864672    |



- |                        |
|------------------------|
| <b>WOMEN'S   S-3XL</b> |
| Cabernet   2865496     |
| Blue   2864673         |
| Teal   2864674         |



## PERFORMANCE LONG SLEEVE

- |                      |                        |
|----------------------|------------------------|
| <b>MEN'S   S-3XL</b> | <b>WOMEN'S   S-3XL</b> |
| Dark Blue   2865437  | Dark Rose   2865478    |
| Rust   2865438       | Dark Blue   2865479    |
| Gray   2865439       | Gray   2865480         |



## PERFORMANCE SHIRT

- |                      |
|----------------------|
| <b>MEN'S   S-3XL</b> |
| Sand   2865497       |
| Cypress   2865498    |



## PIT SHIRT TOP SELLER

- |                                  |
|----------------------------------|
| <b>MEN'S   SIZE VARIES</b>       |
| <b>NEW</b> Tan   S-3XL   2866413 |
| Cypress   S-3XL   2864561        |
| Black   XS-4XL   2862526         |
| Navy   S-3XL   2833043           |

# HELMETS & GOGGLES



**NEW**  
OLIVE/BLACK  
2866467

## TENACITY 4.0

COMBINATION OF MODERN STYLE AND PREMIUM PROTECTION WITH INCREDIBLE VALUE XS-2XL

### SHELL

- Shock-resistant, injection-molded thermoplastic

### WEIGHT

- 1,500g

### FEATURES

- Through-flow, full-helmet ventilation
- ProClip quick release chin strap allows you to fasten the chin strap in seconds
- Removable breath box
- Toolless adjustable roost shield
- Removable, washable liner
- DOT/ECE 22.06 dual certified helmet shell

FULL DETAILS ONLINE



APPAREL

JERSEYS & GLOVES

HATS & GAITERS



**NEW**  
RED  
2866418

## 509 KINGPIN **FOR POLARIS**

PREMIUM MATERIALS, ATTRACTIVE PRICE

### FEATURES

- Built for off-road, the oversized cylindrical lens delivers optimal peripheral vision
- Metal tear-off posts provide strength and durability
- Quick-change technology allows you to run the best lens tint for conditions

FULL DETAILS ONLINE



OUTERWEAR & CASUALWEAR

HELMETS & GOGGLES



**NEW**  
RADIANT TEAL  
2866423

## 509 MX6 **FOR POLARIS**

SUPER WIDE FIELD OF VIEW, ENGINEERED FOR DIRT

### FEATURES

- PC outer lens with anti-scratch coating, and internal anti-fog coating
- Outriggers with latch system for quick lens change
- 45mm strap with silicone to hold strap in place

FULL DETAILS ONLINE



## SEE OUR FULL LINE OF HOME & COLLECTIBLES ONLINE



### KICKBACK ROCKER

Green | 2864816  
Blue | 2862626



### POLARIS KEY RACK

12" x 8" | 2864718



### 15 OZ CAMPFIRE MUG

2861613

# WHEN YOU'RE TRUSTED BY MILLIONS, YOU GET TO WORK.



## **POLARIS SPORTSMAN**

ATVs for trail and adventure riders, hunters, ranchers and anyone who wants to explore the outdoors.



## **POLARIS RZR**

The #1 sport side-by-side lineup, with the most complete lineup for whatever terrain you ride. From tight mountain trails, to deep in the backwoods, to steep dunes.



## **POLARIS RANGER**

The most capable UTVs, purpose-built to be the hardest working and the smoothest riding.



**THEY SAY IT TAKES 10,000 HOURS TO MASTER SOMETHING.  
WE'VE BEEN BUILDING FOR OVER 70 YEARS.**

**WE RELENTLESSLY TEST OUR VEHICLES TO BETTER THE RIDE,  
SO YOU CAN DO WHAT YOU WERE PUT HERE FOR.**



**POLARIS  
XPEDITION**

Elevated performance and all-season comfort to go beyond the trailhead.



**POLARIS  
GENERAL**

The #1 crossover brand. Versatility, comfort and capability to hit the trails or knock out tasks.



## GENERAL XP 1000 2/4 ULTIMATE

ENGINE TYPE / HP	999cc, 4-Stroke DOHC, Twin Cylinder / 100HP		999cc, 4-Stroke DOHC, Twin Cylinder / 100HP		999cc, 4-Stroke DOHC, Twin Cylinder / 100HP	
DRIVETRAIN (DRIVE SYSTEM)	True On-Demand AWD/2WD/ VersaTrac Turf Mode		True On-Demand AWD/2WD/ VersaTrac Turf Mode		True On-Demand AWD/2WD/ VersaTrac Turf Mode	
FRONT/REAR SUSPENSION	Walker Evans Velocity Series Shocks High Clearance A-Arms 14" (35.6 cm) of Travel		Walker Evans Velocity Series Shocks High Clearance A-Arms 14" (35.6 cm) of Travel		Walker Evans Velocity Series Shocks High Clearance A-Arms 14" (35.6 cm) of Travel	
FRONT TIRES & REAR TIRES	30 x 10-15; Pro Armor Crawler XGF 30 x 10-15; Pro Armor Crawler XG		30 x 10-15; Pro Armor Crawler XGF 30 x 10-15; Pro Armor Crawler XG		30 x 10-15; Pro Armor Crawler XGF 30 x 10-15; Pro Armor Crawler XG	
OVERALL VEHICLE SIZE (L X W X H)	118.2 x 64 x 77 (300 x 162.5 x 190.5 cm)	150.2 x 64 x 77 (381.5 x 162.5 x 195.1 cm)	118.2 x 64 x 77 (300 x 162.5 x 190.5 cm)	150.2 x 64 x 77 (381.5 x 162.5 x 195.1 cm)	118.2 x 64 x 77 (300 x 162.5 x 190.5 cm)	150.2 x 64 x 77 (381.5 x 162.5 x 195.1 cm)
GROUND CLEARANCE	13.5" (34.3 cm)		13.5" (34.3 cm)		13.5" (34.3 cm)	
SEATING CAPACITY	2 / 4		2 / 4		2 / 4	
BOX CAPACITY	600 LB (272 KG)		600 LB (272 KG)		600 LB (272 KG)	
TOW CAPACITY	1,500 LB (680 KG)		1,500 LB (680 KG)		1,500 LB (680 KG)	
OTHER STANDARD FEATURES	<b>Premium Features Plus:</b> 7" Display Powered by RIDE COMMAND with Integrated Rear Camera, Rockford Fosgate® Stage 3 Audio		<b>Sport Features Plus:</b> Rockford Fosgate® Stage 1 Audio with PMX Head Unit, Convex Rear-View Mirror, Padded Center Console		Poly Sport Roof, Low-Profile Sport Bumper, 4,500 LB Winch, Dumping Cargo Box, Premium Half Doors, LED Headlight with Accent and LED Taillights, Dual-Sweep Analog Gauge with 4" LCD Rider Information Center	



## GENERAL XP 1000 2/4 PREMIUM



## GENERAL XP 1000 2/4 SPORT



## GENERAL 1000 PREMIUM

ENGINE TYPE / HP	999cc, 4-Stroke DOHC, Twin Cylinder / 100HP	999cc, 4-Stroke DOHC, Twin Cylinder / 100HP
DRIVETRAIN (DRIVE SYSTEM)	True On-Demand AWD/2WD/ VersaTrac Turf Mode	True On-Demand AWD/2WD/ VersaTrac Turf Mode
FRONT/REAR SUSPENSION	FOX® 2.0 Podium QS3 Dual A-Arm with Stabilizer Bar 12.25" (31.1 cm) / 13.2" (33.5 cm) of Travel	ZF Sachs Twin Tube Dual A-Arm with Stabilizer Bar 12.25" (31.1 cm) / 13.2" (33.5 cm) of Travel
FRONT TIRES & REAR TIRES	27 x 9-14; Maxxis® Coronado 27 x 11-4; Maxxis® Coronado	27x9-12; CST® Clincher 27x11-12; CST® Clincher
OVERALL VEHICLE SIZE (L X W X H)	116.4 x 62.5 x 73.8" (295.6 x 158.7 x 187 cm)	116.4 x 62.5 x 73.8" (295.6 x 158.7 x 187 cm)
GROUND CLEARANCE	12" (30.5 cm)	12" (30.5 cm)
SEATING CAPACITY	2	2
BOX CAPACITY	600 LB (272 KG)	600 LB (272 KG)
TOW CAPACITY	1,500 LB (680 KG)	1,500 LB (680 KG)
OTHER STANDARD FEATURES	<b>Sport Features Plus:</b> FOX® 2.0 Podium QS3 Shocks, LED Headlight with Accent and LED Taillights, 14" Wheels and 27" Maxxis Coronado Tires	Sport Chassis, Adjustable Tilt Steering, Dumping Cargo Box, Premium Full Doors, Aluminum Wheels, Dual-Sweep Analog Gauge with 4" LCD Rider Information Center



## GENERAL 1000 SPORT





# LIVE LIFE OFF ROAD.

Warning: Polaris Off-road vehicles can be hazardous to operate and are not designed for on-road use. Driver must be at least 16 years old with a valid driver's license to operate. All riders should always wear helmets, eye protection and footwear. Read, understand and follow your owner's manual. Ride within the limits of your own abilities and never engage in stunt or exhibition driving. Never ride under the influence of drugs or alcohol. All riders should take a safety training course. Call 800-342-3764 for additional information.

Unless noted, trademarks are the property of Polaris Industries Inc. 509® is a registered trademark of Teton Outfitters, LLC. Apple® and App Store® are registered trademarks of Apple Inc. Bluetooth® is a registered trademark of Bluetooth Sig, Inc. Caliber® is a registered trademark of Caliber, Inc. Cardo® is a registered trademark of CARDO SYSTEMS LTD. CruzTools® is a registered trademark of CYCOACTIVE, INC. Facebook™ is a service trademark of META PLATFORMS, INC. Fidlock® is a registered trademark of Fidlock GmbH. FOX® is a registered trademark of Fox Factory Inc. Google Play™ is a service trademark of Google LLC. YouTube® is a registered trademark of GOOGLE LLC. Instagram™ is a service trademark of Instagram, LLC. MORFLEX® is a registered trademark of FNA Group, Inc. NOCO Genius® is a registered trademark of The Noco Company. Pandora® is a registered trademark of Pandora Media, LLC. RHINO-RACK® is a registered trademark of Rhino Rack Australia Pty Limited. Rigid® is a trademark of JST Performance, LLC d/b/a Rigid Industries LLC. Rockford Fosgate® is a registered trademark of Rockford Corporation. SMART BOARD® is a registered trademark of SMART TECHNOLOGIES ULC UNLIMITED LIABILITY CORPORATION CANADA. Tiger Drylac® is a registered trademark of TIGER COATINGS GMBH & CO.KG. ULTRA CROSS® is a registered trademark of THE CARLSTAR GROUP LLC. X™ is a service trademark of X CORP. Prices, Fitment and Availability are subject to change at any moment. Copyright © 2025 Polaris Industries Inc. All rights reserved.



# THE AMERICAN POWERSPORTS CO.



At Polaris, we believe being an American company isn't a sales pitch; it's a way of doing business. It's the place we call home. The place our riders call home.

It all began here in America—over 70 years ago—in a small factory in Roseau, Minnesota. There, our founders forged a company built on American values, grit and ingenuity. That factory is not so small anymore and still operates to this day—creating jobs and producing the best our industry has to offer. The best America has to offer.

Today, we continue to design, engineer and test our industry-leading vehicles with owners like you—right here on American dirt, sand, snow and soil.



POLARIS GLOBAL HEADQUARTERS  
MEDINA, MINNESOTA, USA



CONNECT ONLINE  
SEARCH "POLARISORV"

LEARN MORE  
ABOUT THE POLARIS STORY



**VISIT [POLARIS.COM/GENERAL](https://www.polaris.com/general)**  
TO SEE VEHICLE OPTIONS AND VIEW ACCESSORIES  
ON YOUR NEW MACHINE FROM EVERY ANGLE!

**POLARIS**  
Think Outside

MY26 GENERAL CATALOG ENGLISH OCT '25  
9959125