



POLARIS SPORTSMAN



POLARIS

2026

ENGLISH VERSION

POLARIS
SPORTSMAN

TOUGH DOESN'T QUIT

When we say we put our machines to the test, we mean it. That's why we created industry-leading technology to help get the job done, developed a smoother more versatile ride and added comfort to make the experience even better. You don't stop at good enough and neither will we because tough doesn't quit.

WATERWAY TEST // SPORTSMAN 570 →

POLARIS PROVING GROUNDS



2026 LINEUP

SEE THE FULL LINEUP AT [POLARIS.COM/SPORTSMAN](https://polaris.com/sportsman)

POLARIS
SPORTSMAN

450 / 570

P. 24

RECREATION & UTILITY



SPORTSMAN 450 H.O.
(EPS)



SPORTSMAN 570
(EPS, PREMIUM - 40TH ANNIVERSARY EDITION,
TRAIL, ULTIMATE)



SPORTSMAN X2 570

WORK



SPORTSMAN 6X6 570

TOURING



SPORTSMAN TOURING 570
(PREMIUM, ULTIMATE)

850 / XP 1000 / XP 1000 S

P. 40

RECREATION & UTILITY

SPORT PERFORMANCE



SPORTSMAN 850
(PREMIUM, TRAIL, MUD EDITION)



SPORTSMAN XP 1000
(ULTIMATE, MUD EDITION)



SPORTSMAN XP 1000 S

TOURING



SPORTSMAN TOURING 850
PREMIUM



SPORTSMAN TOURING
XP 1000 TRAIL

SCRAMBLER 850 / XP 1000 S

P. 48

SPORT PERFORMANCE



SCRAMBLER 850



SCRAMBLER XP 1000 S

YOUTH

P. 52



2025 OUTLAW 70 EFI

4 2026 OVERVIEW

- 6 RECREATION & UTILITY MODELS
- 8 TOURING & SPORT MODELS
- 10 SPECIAL EDITION MODELS
- 12 YOUTH SIDE-BY-SIDE & ATV MODELS
- 16 RIDE COMMAND
- 18 POLARIS ENGINEERED PARTS & ACCESSORIES

ACCESSORIES & MAINTENANCE

- 24 450 / 570 (570 X2, 570 6X6 & TOURING 570)
- 40 850 / XP 1000 / XP 1000 S
- 48 SCRAMBLER 850 / XP 1000 S
- 52 MISCELLANEOUS & YOUTH

COMMON ACCESSORIES

- 54 WINCHES
- 56 PLOWS
- 58 TRACKS
- 60 LIGHTING
- 62 CONNECTED TECHNOLOGY
- 64 HUNT
- 66 COOLERS
- 68 WHEELS & TIRES
- 74 TIRE SEALANT & TRAILERING

MAINTENANCE & GARAGE

- 78 OIL & LUBRICANTS
- 80 GARAGE ACCESSORIES
- 82 BATTERY CHARGERS & SERVICE PARTS
- 84 HEAVY DUTY PARTS

APPAREL

- 87 JERSEYS, GLOVES & GAITERS
- 87 RANGE COLLECTION
- 88 CASUALWEAR & HATS
- 89 HELMETS & GOGGLES

90 2026 LINEUP & SPECIFICATIONS

SHOP ALL SPORTSMAN ACCESSORIES
AT [POLARIS.COM/SHOPSPORTSMAN](https://polaris.com/shopsportsman)

SPORTSMAN LEGENDARY TOUGH



Sportsman and Scrambler ATVs deliver legendary ride and handling, remarkable versatility and unbeatable durability, optimizing performance for work or play. Confidently take on rough trails, efficiently conquer tough tasks and achieve more.



SMOOTH

STAY CONFIDENT AND COMFORTABLE | Ride longer with Sportsman's legendary ride and handling, optimized by independent-rear suspension, on-demand AWD and class-leading ground clearance.



STRONG

TACKLE THE TOUGH STUFF | Take on any job with durability and strength, thanks to sealed suspension bushings and up to 1,750 LB towing capacity.



VERSATILE

BRING WHAT YOU NEED | Load up your gear and tools effortlessly. And if you're looking for the perfect fit, customize your ATV for work or play with a wide range of accessory options.



SPORTSMAN

TACKLE TOUGH JOBS & THRILLING ADVENTURES

SPORTSMAN RECREATION & UTILITY MODELS

DELIVERING LEGENDARY RIDE AND HANDLING. The Polaris Sportsman ATVs are multi-use vehicles that can help you get more done in a day on your property, farm or ranch and take your hunting passion further.

SPORTSMAN 450 H.O. AVAILABLE IN H.O. AND EPS TRIMS

SMOOTH

9.5" rear suspension travel and 11.5" of ground clearance to help soak up trail ruts and bumps

Multi-select EPS enables more effortless handling—reducing body fatigue

On-demand AWD delivers instant traction when the slightest wheel spin is detected

STRONG

Improved clutch airflow to help keep water out

Confidently pull trailers and other vehicles with 1,350 LB towing capacity

VERSATILE

270 LB rack capacity to help haul more gear

5 gallon integrated sealed storage

Pre-wired, plug-and-play harness for a winch, plow or hand warmers

SPORTSMAN 570 AVAILABLE IN 570, EPS, PREMIUM - 40TH ANNIVERSARY EDITION, TRAIL AND ULTIMATE TRIMS

SMOOTH

9.5" of rear suspension travel and 11.5" of ground clearance to reduce the impact of ruts and bumps

On-demand AWD delivers instant traction when the slightest wheel spin is detected
Engine braking system (EBS), Active Decent Control (ADC) and Multi-select EPS for greater control over your ride*

STRONG

Industry-exclusive Plow Mode simplifies plowing**

1,350 LB towing capacity to handle heavier loads

3,500 LB Winch delivers pulling power to effortlessly handle heavier loads*

VERSATILE

11 gallons of sealed storage offers more space to stash your tools and supplies*

Confidently navigate tasks and trails with the 7" Display, powered by RIDE COMMAND**

LED lighting available on Sportsman 570 EPS and above trims to enhance visibility while cornering

*Available on select trims

**Standard on Sportsman 570 Ultimate





SPORTSMAN 850

AVAILABLE IN 850, PREMIUM AND TRAIL TRIMS

SMOOTH

12" of ground clearance provides ample space to overcome obstacles
 Multi-select EPS enables more effortless handling—reducing body fatigue
 Sealed suspension bushings minimize maintenance and deliver a smoother ride
 On-demand AWD delivers instant traction when the slightest wheel spin is detected

STRONG

Easily haul heavy loads with a 1,500 LB towing capacity
 3,500 LB Winch with synthetic rope for extra pulling power*
 78 HP ProStar engine delivers the power you need for work and play

VERSATILE

LED pod and headlights enhance visibility**
 360 LB front and rear rack capacity to get more done

*Available on Sportsman 850 Trail

**Available on Sportsman 850 Premium and Trail Trims



SPORTSMAN XP 1000 ULTIMATE

SMOOTH

High-clearance A-arms and 12" of ground clearance that provide more space to overcome obstacles
 On-demand AWD delivers instant traction when the slightest wheel spin is detected
 27" Duro tires on 14" aluminum wheels, offer extra grip
 Multi-select EPS enables more effortless handling—reducing body fatigue

STRONG

Industry-exclusive Plow Mode makes plowing snow quick and easy
 Pull and tow more weight with a 1,500 LB towing capacity and 3,500 LB Winch
 Ultimate Series front and rear bumpers and a 90 HP engine to keep you going when the trail gets tough

VERSATILE

Confidently navigate tasks and trails with the 7" Display, powered by RIDE COMMAND
 Pre-installed RIDE COMMAND+ to experience hassle-free ownership
 360 LB rack capacity and 6 gallons of combined storage to bring more gear



MAKE IT TRULY YOURS

Choose from a variety of tested and trusted Polaris Engineered accessories to customize your SPORTSMAN for how you ride.

[SCAN TO LEARN MORE](#)

SPORTSMAN

DISCOVER THE TRAILS LESS TRAVELED



SPORTSMAN TOURING MODELS

TAKE ON AN ADVENTURE FOR TWO. Hit the trails less traveled with the versatility to ride in comfort, alone or 2-Up with a friend.

SPORTSMAN TOURING 570
AVAILABLE IN TOURING 570, PREMIUM
AND ULTIMATE TRIMS

COMFORT TO GO THE DISTANCE

9.5" of rear travel and 11.5" of ground clearance help soak up trail ruts and bumps

Engine braking system (EBS), Active Descent Control (ADC) and multi-select EPS for greater control over your ride*

Contoured seat back and hand grips offer more comfort

VERSATILITY TO DO MORE

11 gallons of storage to haul more of what you need

LED pod and headlights offer enhanced lighting*

MADE TO EXPLORE

3,500 LB Winch with synthetic rope to clear heavier obstacles in your way*

Front rack extender and 270 LB rack capacity allows you to pack more gear and safely secure it

Confidently navigate tasks and trails with the 7" Display, powered by RIDE COMMAND*

*Available on select trims



SPORTSMAN TOURING 850 PREMIUM

SMOOTH

9"/10.25" front/rear suspension travel with arched dual A-arms help smooth out rough rides

On-demand AWD detects tire slip and delivers instant traction

Engine braking system (EBS) with Active Descent Control (ADC) optimizes ride and handling

STRONG

78 HP engine that delivers impressive power

Get more done with a 1,500 LB towing capacity

VERSATILE

6 gallons of integrated storage to stow essentials

LED steerable pod and headlights offer enhanced visibility



SPORTSMAN TOURING XP 1000 TRAIL

SMOOTH

Arched dual A-arms help smooth out rough rides

On-demand AWD delivers instant traction

Engine braking system (EBS) with Active Descent Control (ADC) optimizes ride and handling

STRONG

27" Duro tires with 14" aluminum wheels offer more traction and strength

Durable handguards allow you to stay comfortable and focused

3,500 LB Winch to clear tough obstacles

88 HP engine to forge ahead on tough trails

VERSATILE

Steerable pod and LED headlights offer enhanced visibility

6 gallons of integrated storage to stow your essentials





DESIGNED FOR PERFORMANCE AND CONTROL



SPORTSMAN SPORT MODELS

OWN THE TRAIL OR TACKLE THE DESERT. Whether powering over dirt and rock, or winding through trees and mountains, Polaris ATVs provide an exhilarating trail experience, allowing you to explore the outdoors by yourself or with a group.

SPORTSMAN XP 1000 S

SMOOTH

Walker Evans adjustable shocks to shrug off bumps and optimize comfort

A smooth and controlled ride with 14" of long-travel at the rear

Industry-leading 55" width that keeps you grounded and tracking

STRONG

Tow up to 1,750 LBS and move mountains of work

Load everything you need with a combined 500 LB rack capacity

VERSATILE

3,500 LB Winch to help you remove downed trees

SCRAMBLER 850

SMOOTH

All day comfort with sport tuned independent rear suspension

Sport-sculpted seat to reduce fatigue

STRONG

Performance-tuned ProStar engine that delivers a heart-pounding 78 HP

26" CST tires and 14" steel wheels offer the traction to confidently take on rough terrain

VERSATILE

Wider floorboards and a narrower stance at the knees optimize handling and control

A nimble 48" width enhances maneuverability

SCRAMBLER XP 1000 S

SMOOTH

Walker Evans adjustable shocks to shrug off bumps and optimize comfort

Industry-leading 55" width that keeps you grounded and tracking

14.5" of ground clearance to overcome obstacles

STRONG

Performance-tuned ProStar engine that delivers a heart-pounding 89 HP

27" Duro Tires & 12" aluminum wheels to soak up rough terrain

VERSATILE

An adjustable 3" handlebar riser allows you to find the perfect fit

Easily ride in the early mornings or evenings with LED headlights



MAKE IT TRULY YOURS

Choose from a variety of tested and trusted Polaris Engineered accessories to customize your SPORTSMAN for how you ride.

SCAN TO LEARN MORE

SPORTSMAN

MORE POWER TO ROAM FURTHER

SPORTSMAN SPECIAL EDITION MODELS

PURPOSE BUILT TO DISCOVER MORE. Whether you need to get to a hard to reach hunting spot, get work done before, during or after the trail ride, or power through your favorite mud hole, Sportsman can take you there and then some.

SPORTSMAN X2 570

ALL-DAY COMFORT

Active Decent Control (ADC), engine braking system (EBS) and multi-select electronic power steering (EPS) deliver a more controlled ride
On-demand AWD detects tire slip and delivers instant traction

READY TO WORK

Industry-exclusive 400 LB dump box helps you get big tasks done, faster
Front bumper for added protection
Ride Control: easy-effort throttle, speed limiting, geofencing, PIN-activated security system
3,500 LB Winch with synthetic rope to clear heavier obstacles in your way

VERSATILITY TO DO MORE

Convertible passenger seat
Turf Mode for when you need to tread gently on delicate surfaces, like grass
LED pod and headlights offer enhanced visibility

SPORTSMAN 6X6 570

ALL-DAY COMFORT

Active Decent Control (ADC), engine braking system (EBS) and multi-select electronic power steering (EPS) deliver a more controlled ride
Upgraded sealed bushings and 11.5" of ground clearance work together to absorb trail ruts and bumps

ADVANCED CAPABILITY

Class-leading 800 LB dump box featuring factory-integrated D-rings with multiple tie-down points to secure cargo
3,500 LB winch with synthetic rope and Auto Stop to clear heavier obstacles in your way
Ride Control: Easy effort throttle, speed limiting, geofencing, PIN-activated security system

VERSATILITY TO DO MORE

Easily ride with friends or family with a passenger seat
LED pod and headlights offer enhanced visibility





SPORTSMAN 850 MUD EDITION

SMOOTH

On-demand AWD with Mud Edition-specific front drive makes it easier to emerge from tough mud pits
 13.5" of ground clearance provides more room to overcome obstacles

STRONG

78 HP engine to keep you moving through thick mud
 Shielded clutch and advanced engine ducting so you can navigate a mud hole with ease

VERSATILE

Front rack-mounted radiator for optimal engine cooling
 Sealed LED headlights provide enhanced visibility

SPORTSMAN XP 1000 MUD EDITION

SMOOTH

On-demand AWD with Mud Edition-specific front drive makes it easier to emerge from tough mud pits
 13.5" of ground clearance provides more room to overcome obstacles

STRONG

85 HP engine to keep you moving through thick mud
 Shielded clutch and advanced engine ducting so you can navigate a mud hole with ease
 3,500 LB Winch with synthetic rope for extra pulling power

VERSATILE

Front rack-mounted radiator for optimal engine cooling
 Sealed LED headlights provide enhanced visibility
 Handlebar grab hoop enhances the rider's ability to position their body to maneuver through mud holes



MAKE IT TRULY YOURS

Choose from a variety of tested and trusted Polaris Engineered accessories to customize your SPORTSMAN for how you ride.

[SCAN TO LEARN MORE](#)

YOUTH SIDE-BY-SIDES & ATVs

INSPIRE CONFIDENCE OFF-ROAD



Empower child riders to take their own off-road adventures with youth vehicles built for comfort and control. Our kids' off-road lineup features small ATVs, quads, 4-wheelers and side-by-sides designed for a range of children's ages and experience levels—all with industry-leading safety features.



SAFETY FEATURES PARENTS LOVE

SAFE AND SOUND | Enjoy peace of mind knowing that Polaris youth models come with industry-leading safety features designed to build a solid foundation for the next generation of riders.



KID-FRIENDLY PERFORMANCE

HAVE A DAY | Kids can confidently tackle adventures thanks to age-appropriate ergonomics, capable suspension and plenty of ground clearance to clear obstacles.



GROW WITH POLARIS

RIDE EARLY. RIDE OFTEN. | We build confidence-inspiring youth model ATVs and side-by-sides. We offer ATVs made for riders ages 6+, 10+, 14+ and side-by-sides for riders aged 10+.



YOUTH SIDE-BY-SIDES & ATVs

KID-FRIENDLY PERFORMANCE

RZR 200 EFI

SXS PERFORMANCE FOR THE NEXT GENERATION. Give kids RZR performance and empower them while fostering a love for outdoors with leading safety technology parents will appreciate like Helmet Aware, kid-friendly performance and power that grows with them. The RZR 200 is made for riders ages 10+ with adult supervision.

RZR 200 EFI

180cc 4-stroke single cylinder engine
10" ground clearance
24" tires
48" wide
Age: 10+



2025 RANGER 150 EFI

SXS CAPABILITY FOR THE NEXT GENERATION. Introduce kids to legendary RANGER ride and handling with adaptable power that can grow with them. It's equipped with leading safety features like Helmet Aware Technology and Youth Ride Control for parents' peace of mind. RANGER 150 EFI is made for riders 10+ with adult supervision.

2025 RANGER 150 EFI

150cc 4-stroke single cylinder engine
8" ground clearance
22" tires
48" wide
Age: 10+





PHOENIX 200

PERFORMANCE FOR BIGGER ADVENTURES. Inspiring confidence off-road. Perfect way to introduce young riders to riding the trails. Ages 14+ with adult supervision.

SPORTSMAN 110 EFI, OUTLAW 110 EFI, & 2025 OUTLAW 70 EFI

INSPIRING CONFIDENCE OFF ROAD. The Sportsman and Outlaw Youth ATVs are perfect to introduce young riders to riding the trails. The Sportsman 110 and Outlaw 110 models are made for riders ages 10+ with adult supervision, while the Outlaw 70 is for riders ages 6+.

PHOENIX 200

- 196cc 4-stroke single cylinder engine
- 7" of front and 6.5" of rear suspension travel
- 21" front and 20" rear tires for traction & stability
- Adjustable Speed Limiter
- Safety Whip Flag
- Age: 14+

SPORTSMAN 110 EFI

- 112cc 4-stroke single cylinder engine
- 3.5" ground clearance
- 36.75" wide
- Age: 10+

OUTLAW 110 EFI

- 112cc 4-stroke single cylinder engine
- 3.5" ground clearance
- 36.75" wide
- Age: 10+

2025 OUTLAW 70 EFI

- 70cc 4-stroke single cylinder engine
- 4" ground clearance
- 35.5" wide
- Age: 6+



OFF ROAD, IN TOUCH





POLARIS RIDE COMMAND

ENHANCE YOUR RIDE

Take your ride to the next level with RIDE COMMAND. Whether you're tackling tasks or exploring new trails, RIDE COMMAND helps you work smarter and ride with confidence. Access GPS navigation, customizable gauges, waypoints and more—right from your 7" Display, the free Polaris app, or the RIDE COMMAND website. And the best part? It all works even without cell service, so you're ready for whatever comes next.

POLARIS RIDE COMMAND+

PLUS UP OWNERSHIP

Stay connected and in control with RIDE COMMAND+. This premium upgrade gives you added peace of mind by putting key vehicle insights right at your fingertips. Through the Polaris app, you can check your vehicle's health, monitor maintenance, identify vehicle issues that may arise and more. It's the smarter way to make sure your ride is ready when you are.



VEHICLE HEALTH

Remotely monitor battery life, fuel level, oil change status and more.



ISSUE DIAGNOSTICS

Stay proactive in your upkeep and avoid unexpected downtime.



MAINTENANCE REMINDERS

Stay on top of routine maintenance and remain confident you haven't missed anything important.

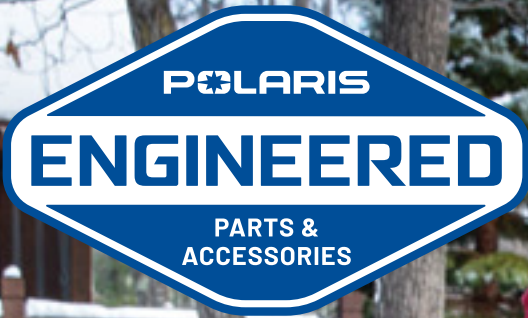

A woman with blonde hair, wearing a red and grey winter jacket, black pants, and a white helmet with goggles, is riding a grey Polaris Sportsman ATV. The ATV is equipped with a large windshield, a front rack, and a rear storage box. It is parked on a snowy surface in a wooded area with bare trees. The ATV's headlights are on.

PARTS AND ACCESSORIES DESIGNED TO FIT YOUR SPORTSMAN

DESIGNED

by the people who designed your vehicle.

TESTED

in the field so you ride with 100% confidence.

TRUSTED

70 years in the business. The #1 name in off-road.

KEEP YOUR STANDARDS HIGH. WE DO.



WE HOLD OUR PARTNERS TO THE SAME STANDARDS

Sharing an outdoor adventure with a companion or two gives your experience its very own energy. When we meet another brand that builds and tests their products with the same rigor as we do, a kinship forms. So we give them an exclusive partner badge and invite them along for the ride. It's another way we bring you the best options for customizing your Polaris vehicle without compromise. How better to send you and your crew out into the world?



ACCESSORIES
BACKED BY A



WARRANTY



ENHANCE YOUR RIDE

WITH INTEGRATED ACCESSORIES

Ensuring Polaris Engineered Accessories fit and work in sync with your machine is the most critical phase of testing and validation. With seamless integration, you can trust that any Polaris accessory you install will enhance your experience beyond your expectations.



CARGO VERSATILITY

Lock & Ride mounting locations allow for limitless customization to let you work the way you want.

P. 29, 34, 44

POLARIS RIDECOMMAND

ENHANCE YOUR RIDE

Ride in confidence with industry-leading technology showing you the way.

P. 62



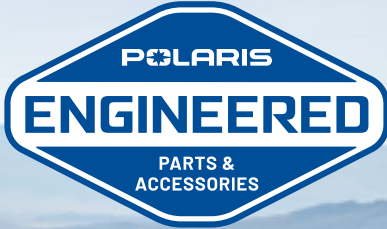

PRO SERIES

INTEGRATED WINCH MOUNT & PRE-WIRED

Designated mounting points and pre-wired connectors for a perfect fit and the strongest place to attach a Polaris Engineered winch - the most dependable winch for your Sportsman. With wiring built right into the vehicle, we made this the easiest winch to install on a Sportsman.

P. 54



INTEGRATED PLOW MOUNT

The attachment points for the Plow System are integrated right at the factory and feature an innovative drive-up and go installation process.

P. 56

ENHANCE YOUR RIDE

WITH INTEGRATED ACCESSORIES

PRO SERIES



1 YR
WARRANTY



- 1 Sealed permanent magnet motor
- 2 Cut steel gears and sealed drivetrain

3 PREMIUM SYNTHETIC ROPE

With its lightweight, yet extremely strong, design and superior flexibility, this 50' long synthetic rope is easy to handle and can stand up to any tough job.

4 RAPID ROPE RECOVERY 5x FASTER

Retrieve cable 5x faster than standard mode on other Polaris winches. Get back to riding or complete your task quicker.

5 AUTO STOP TECHNOLOGY

Auto Stop technology protects and extends the life of your winch by automatically stopping the winch at the end of pull to prevent over-spooling. While plowing, it prevents the plow frame from bending by stopping the winch once the plow has been lifted.

6 WIRELESS REMOTE

This convenient remote operates your Polaris winch wirelessly from within 50' of the vehicle. Operate your winch safely outside your vehicle while on the job site or trails.

**LEARN MORE ABOUT
POLARIS ENGINEERED WINCHES**

P. 54



7 Pre-wired chassis & no need to cut panels

Factory-installed wiring makes the controls simple to install. Mount the winch, connect the wires and trust that everything is routed safely, securely and properly.

- 8 Tested 1,200+ pulls at max load
- 9 Built to withstand -20° F temperatures
- 10 Operates fully submerged underwater
- 11 Military tested and approved

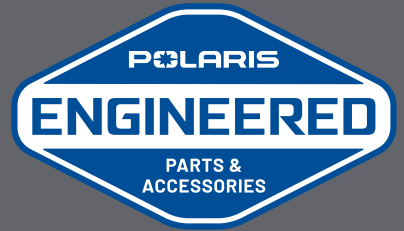

Right from the factory, your vehicle is built to make essential accessories like winches and plows easy to use day-in and day-out. Mounting brackets are designed into the oversized factory bumper and wiring is routed securely and properly. When it comes to Sportsman, Polaris Engineered Accessories make work easier so you can get more done.

POLARIS PLOW SYSTEMS

- ✓ Easily install and remove the plow system from your Sportsman
- ✓ No loss of factory ground clearance when not plowing
- ✓ Don't have to crawl under the machine to release the plow blade from the vehicle
- ✓ No trimming of vehicle plastic required to mount plow or winch
- ✓ Angle your blade right from your seat with the Plow Hydraulic Angle System
- ✓ 30 seconds: Drive up, hook on, lock down and go

LEARN MORE ABOUT
THE POLARIS PLOW SYSTEM

P. 56



DRIVE UP



HOOK ON



LOCK DOWN



TRAIL RIDING PACKAGE

SCAN TO SHOP THIS PACKAGE



- 2890579-266 Ultimate Series Handguard Kit P. 28
- 2891194 Pod Bag P. 29
- 2891193 Fender Bag P. 29
- 2885002 Hand & Thumb Warmer Kit P. 37



- 2889886 Rear Power Harness P. 37
- 2883128 RIGID® D-Series Pro Driving LED Light P. 60
- 2882320 LED Light Bar Wiring Harness P. 61
- 2879860 LED Y-Harness P. 61



HUNT PACKAGE

SCAN TO SHOP THIS PACKAGE



- 2885002 Hand & Thumb Warmer Kit P. 28
- 2890581  Semi-Rigid Storage Bag P. 29
- 2890617  Medium 14" Clear Windshield P. 30
- 2883123 RIGID® SR-Series 10" Combo LED Light P. 61

- 2882320 LED Light Bar Wiring Harness P. 61
- 2882426 Kolpin Stronghold Gun Boot L P. 64
- 2884846 Kolpin Stronghold Auto-Latch Mount P. 64
- 2884119  Rhino Grip Pro - ATV P. 65





LANDOWNER PACKAGE

SCAN TO SHOP
THIS PACKAGE



2890877

Open Cargo Box P. 29

2890617

Medium 14" Clear Windshield P. 30



WINTER PACKAGE

SCAN TO SHOP
THIS PACKAGE



2885002

Hand & Thumb Warmer Kit P. 28

2879630

Steel ATV Plow Frame P. 57

2890876

Rear Audio Cargo Box P. 29

2880269

Pro Series Plow Blade - 66" Poly P. 57

2890616

Tall 18" Clear Windshield P. 30

2883123

RIGID® SR-Series 10" Combo LED Light P. 61

2891253

Integrated Plow Mount P. 57

2882320

LED Light Bar Wiring Harness P. 61



WINCHES



PRO SERIES

3,500 LB WINCH TOP SELLER

- Adds 3,500 LBS of pulling capacity with Auto Stop Technology for plowing applications
- Rapid Rope Recovery recovers open cable 5x as fast as standard mode on other Polaris winches

» 2891610

SPORTSMAN 450/570 '21-26



3,500 LB WINCH

- Adds 3,500 LBS of pulling capacity with quick and easy installation
- Includes all components required for installation plus 50' of 3/16" premium high-strength synthetic rope

» 2891609

SPORTSMAN 450/570 '21-26



2,500 LB WINCH TOP SELLER

- Adds 2,500 LBS of pulling capacity with quick and easy installation
- Includes all components required for installation plus 50' of 3/16" high-strength steel cable

» 2891608

SPORTSMAN 450/570 '21-26



LEARN MORE P. 54

NEED A PLOW? P. 56

RACKS

FRONT UTILITY RACK TOP SELLER

- Tubular steel rack that attaches on top of front plastic rack providing protection and multiple tie down points
- 3/4" diameter matte black steel tube

» 2884842

SPORTSMAN 450/570 '21-26, EXCEPT '21 AND PRIOR 6X6, X2 AND TOUR MODELS

DOES NOT WORK WITH KOLPIN STRONGHOLD AUTO-LATCH GUN MOUNT (2884846)

CARGO RACK

- Provides extra storage and a sturdy platform for securing items to the back of your ATV
- Replaces your stock rear bumper while increasing your rack size by 33%
- Virtually limitless number of tie-down points
- Has a steel matte black finish

» 2891223

SPORTSMAN 450/570 '21-26

WILL NOT WORK WITH REAR BUMPER: SERVES AS REAR BUMPER / REAR CARGO RACK

REAR UTILITY RACK

TOP SELLER

- Replaces rear plastic rack with a strong flat steel rack with integrated tie down points
- Works with all Lock & Ride accessories, rack extenders and gun mounts

» 2884843

SPORTSMAN 450/570 '21-26

REAR RACK EXTENDER

TOP SELLER

- Forms a 3" tall perimeter around the rear cargo rack to keep gear secure and prevent cargo from sliding off the rear platform
- Durable steel construction provides a sturdy tie down anchor for loose gear
- Compatible with Cargo Boxes and Rear Utility Rack

» 2884841

SPORTSMAN 450/570 '21-26

PROTECTION

REAR GRAB BAR

- Designed to assist in maneuvering the vehicle with ease
- Designated handle to safely and effectively grip when moving the vehicle
- Crafted from high-strength steel to ensure long-lasting performance and reliability
- Quick attachment to the rear of the vehicle

» 2891386

SPORTSMAN 450/570 '21-26

FENDER FLARES

- Shields riders from mud, debris and water
- Installs easily with plastic push pin rivets on factory fenders
- Made from durable, textured poly for a rugged finish

» 2891247

SPORTSMAN 450/570 '21-26

BODY ARMOR

- Provides extra protection to your ATV's full body and fenders

» 2884851

SPORTSMAN 450/570 '21-26

FRONT BUMPER (2884850 OR 2884844) REQUIRED FOR INSTALLATION

DOES NOT WORK WITH KOLPIN STRONGHOLD AUTO-LATCH GUN MOUNT (2884846)

FRONT TRAIL BUMPER TOP SELLER

- Provides enhanced protection from brush and debris
- Has designated light bar holes and is compatible with winch and Body Armor

» 2884844

SPORTSMAN 450/570 '21-26

FRONT BUMPER WITH HITCH

- Adds heavy-duty protection with a custom look
- Has designated light bar holes and is compatible with winch and Body Armor
- Standard front receiver hitch for additional functionality

» 2884850

SPORTSMAN 450/570 '21-26

REAR BUMPER

- Durable 1.25" steel tube with a matte black finish
- Does not block access to the rear storage compartment

» 2890001

SPORTSMAN 450/570 '25-26

NOT COMPATIBLE WITH REAR CARGO BOX SUPPORT (2889866) OR REAR CARGO RACK (2890037)

FRONT BOOT GUARDS

- Made from High Density Poly Ethylene (HDPE)
- Comes with two front guards, one for the left and right
- Protects the CV boot

» STRUT A ARM • 2890059

» DUAL A ARM • 2890064

SPORTSMAN 450/570 '23-26

REAR BOOT GUARDS

- Made from High Density Poly Ethylene (HDPE)
- Comes with two rear guards, one for the left and right
- Protects the CV boot

» 2890866

SPORTSMAN 450/570 '23-26



COMFORT



HANDGUARDS

- Handguard Mount (2889341) is required when installing Polaris Handguards
- Does not fit with windshields

<input type="checkbox"/>	BRIGHT WHITE	2876883
<input checked="" type="checkbox"/>	BLACK <small>TOP SELLER</small>	2876846
<input type="checkbox"/>	INDY RED	2876845

» MOUNT • 2889341
SPORTSMAN 450/570 '21-26



HAND & THUMB WARMER KIT TOP SELLER

- Provides heat to grips and throttle and is easily installed by plugging into pod
 - Includes two heated grips and one throttle warmer
- » 2885002

SPORTSMAN 450/570 '21-26



■ ■ ■ ■ ■
DRIVER HEATED SEAT

- Plug and play seat installs easily
 - Direct replacement for standard seat
 - Integrated heat element, wiring harness and control switch
- » 2891248

SPORTSMAN 450/570 '21-26



ULTIMATE SERIES HANDGUARD KIT

- Protects riders from wind, snow, ice, branches and other trail debris
- Larger design offers increased level of warmth and protection
- Ultimate Series Handguard Kit includes mounts

<input checked="" type="checkbox"/>	POLARIS PURSUIT CAMO	2890579-587
<input checked="" type="checkbox"/>	BLACK	2890579-266

SPORTSMAN 450/570 '21-26
NOT COMPATIBLE WITH WINDSHIELDS



HANDLEBAR MOUNTED MIRRORS TOP SELLER

- Enhances visibility of what's behind you for added safety
- Sold as a pair

» 2890578
SPORTSMAN 450/570 '21-26



LED LIGHT KIT

- Upgrade your standard headlights and pod lights to LEDs with this upgrade kit

» 2884859
SPORTSMAN 450/570 '21-26



REAR POWER HARNESS

- Provides power to the rear of the ATV for electrical accessories including Rear Audio Storage Box

» 2889070
SPORTSMAN 450/570 '21-26

STORAGE



SEMI-RIGID STORAGE BAG

- Fits on either side of rear rack providing riders with more storage options
- Mounts easily with Lock & Ride
- Base is water-resistant to keep your gear dry

» 2890581

SPORTSMAN 450/570 '21-26



POD BAG

- Keep your essentials in reach with 2 liters of storage capacity
- Mounts to the top of the light pod with HD Velcro®
- Semi-rigid construction and PU laminated EVA material keeps belongings protected from the elements
- Compatible with windshields

» 2891194

SPORTSMAN 450/570 '21-26



FENDER BAG

- Provides easy-access 8.3 liters of storage
- Mounts to the front left fender with HD Velcro®
- Semi-rigid construction and PU laminated EVA material keeps belongings protected from the elements

» 2891193

SPORTSMAN 450/570 '21-26



UNDERSEAT BAG

- Provides an extra 8.3 liters of storage capacity
- Mounts directly under your seat via a Velcro® wrap
- Durable semi-rigid construction keeps items protected

» 2889454

SPORTSMAN 450/570 '21-26

NEW

REAR CARGO BOX

- Mounts easily with Lock & Ride
- Includes an integrated padlock hole for added security
- Supports up to 125 LBS of gear
- Provides hard storage solution for helmets and gear

» 2891250

SPORTSMAN 450/570 '25-26



REAR CARGO BOX

- Increase your storage with an extra 85 QTS of dry, dust-proof storage
- Mounts easily with Lock & Ride to the rear rack and is compatible with rack extenders, utility rack and gun mount
- Includes 2 padlock locations

» 2890876

SPORTSMAN 450/570 '21-26



OPEN CARGO BOX

- Increase your storage with an extra 88 QTS of convenient storage space
- Mounts easily with Lock & Ride to the rear rack and is compatible with rack extenders, utility rack and gun mount
- Holds two 5-gallon buckets with integrated grab handle to make it easy to carry and transport cargo
- 12 convenient tie-down locations to secure cargo

» 2890877

SPORTSMAN 450/570 '21-26



REAR COOLER BOX

- Increase your storage with an extra 46 QTS of weather resistant cooler storage
- Mounts easily with Lock & Ride to the rear rack and is compatible with rack extenders, utility rack and gun mount
- Integrated bottle opener and 2 padlock locations

» 2890879

SPORTSMAN 450/570 '21-26



STORAGE BIN NET

- Secure all of your small items and gear
- Made of high quality EPDM rubber

» 2891010

SPORTSMAN 450/570 '25-26



CHAINSAW MOUNT

- Heavy-duty, black powder-coated metal bracket is designed to transport your chain saw securely
- With Lock & Ride technology, it can be secured to the outside of the rack in seconds, without tools, so your chainsaw is within reach at all times
- Accommodates any brand electric chainsaw (sold separately)
- Rubber pads provide cushion and tight fit
- 15 LB weight capacity

» 2890580

SPORTSMAN 450 H.O. '21-26, SPORTSMAN 570 '21-26





WINDSHIELDS



TALL 18" CLEAR
2890616



MEDIUM 14" CLEAR
2890617



TALL 18" CLEAR
FOR RIDE COMMAND
EQUIPPED VEHICLES
2890618

WINDSHIELDS

- Lock & Ride technology allows for easy installation and removal in seconds without tools
- Poly windshields are flexible, impact-resistant and provide long-term value over the life of your machine
- Two heights available for whatever coverage you prefer

SIZE	COLOR	PART #
TALL 18"	CLEAR	2890616
MEDIUM 14"	CLEAR	2890617

SPORTSMAN 450/570 '21-26

FOR RIDE COMMAND EQUIPPED VEHICLES

TALL 18"	CLEAR	2890618
----------	-------	---------

SPORTSMAN 450/570 '23-26 WITH 7" DISPLAY INSTALLED





DO MORE



PLOWS P. 56



WHEELS & TIRES P. 68



LIGHTING P. 60



HUNT P. 64



TRAIL RIDING PACKAGE

SCAN TO SHOP THIS PACKAGE





- | | | | | | |
|---------|------------------------------|-------------|-------------------------------------|---------|---|
| 2889866 | Rear Cargo Box Support P. 34 | 2889908 | Passenger Handguards P. 36 | 2883128 | RIGID® D-Series Pro Driving LED Light P. 60 |
| 2891194 | Pod Bag P. 35 | 2885002 | Hand & Thumb Warmer Kit P. 37 | 2882320 | LED Light Bar Wiring Harness P. 61 |
| 2891193 | Fender Bag P. 35 | 2890579-266 | Ultimate Series Handguard Kit P. 37 | 2879860 | LED Y-Harness P. 61 |
| 2884844 | Front Trail Bumper P. 36 | 2889886 | Rear Power Harness P. 37 | | |



HUNT PACKAGE

SCAN TO SHOP THIS PACKAGE





- | | | | | | |
|---------|--|---------|---|---------|--|
| 2890581 |  Semi-Rigid Storage Bag P. 35 | 2890617 |  Medium 14" Clear Windshield P. 37 | 2882426 | Kolpin Stronghold Gun Boot L P. 64 |
| 2884850 | Front Bumper with Hitch P. 36 | 2883123 | RIGID® SR-Series 10" Combo LED Light P. 61 | 2884846 | Kolpin Stronghold Auto-Latch Mount P. 64 |
| 2885002 | Hand & Thumb Warmer Kit P. 37 | 2882320 | LED Light Bar Wiring Harness P. 61 | | |



LANDOWNER PACKAGE

SCAN TO SHOP THIS PACKAGE



- 2890877  Open Cargo Box P. 34
- 2889866 Rear Cargo Box Support P. 34
- 2890617  Medium 14" Clear Windshield P. 37



WINTER PACKAGE

SCAN TO SHOP THIS PACKAGE



- | | | |
|---|--|--|
| <ul style="list-style-type: none"> 2889866 Rear Cargo Box Support P. 34 2884850 Front Bumper with Hitch P. 36 2885002 Hand & Thumb Warmer Kit P. 37 2889887 Driver Heated Seat P. 37 2889888 Passenger Heated Seat P. 37 | <ul style="list-style-type: none"> 2889906 Passenger Heated Grips P. 37 2890616  Tall 18" Clear Windshield P. 37 2891253 Integrated Plow Mount P. 57 2879630 Steel ATV Plow Frame P. 57 | <ul style="list-style-type: none"> 2880269 Pro Series Plow Blade - 66" Poly P. 57 2883123 RIGID® SR-Series 10" Combo LED Light P. 61 2882320 LED Light Bar Wiring Harness P. 61 |
|---|--|--|



STORAGE & RACKS



NEW REAR CARGO BOX - TOURING

- Mounts easily with Lock & Ride
- Includes an integrated padlock hole for added security
- Supports up to 125 LBS of gear
- Provides hard storage solution for helmets and gear

» 2891250

SPORTSMAN TOURING 570 '25-26



REAR RACK EXTENDER

- Forms a 3" tall perimeter around the rear cargo rack to keep gear secure
- Durable steel construction provides a sturdy tie down anchor for gear

» 2889864

SPORTSMAN TOURING 570 '25-26

NOT COMPATIBLE WITH THE REAR CARGO BOX SUPPORT (2889866)



REAR CARGO BOX SUPPORT

- Allows mounting of cargo boxes when rear seat is installed

» 2889866

SPORTSMAN TOURING 570 '25-26

REQUIRED FOR TOURING 570

NOT COMPATIBLE WITH REAR BUMPER (2890001), REAR RACK EXTENDER (2889864) OR REAR CARGO RACK (2890037)



COOLER CARGO BOX

- 44 QT cooler
- Mounts easily with Lock & Ride
- Tough molded UV-resistant polyethylene construction for optimal ice retention

» 2890879

SPORTSMAN TOURING 570 '25-26

REAR CARGO BOX SUPPORT (2889866) REQUIRED, SOLD SEPARATELY



OPEN CARGO BOX

- 88 QTS of storage
- Mounts easily with Lock & Ride

» 2890877

SPORTSMAN TOURING 570 '25-26

REAR CARGO BOX SUPPORT (2889866) REQUIRED, SOLD SEPARATELY



FRONT UTILITY RACK TOP SELLER

- Tubular steel rack that attaches on top of front plastic rack providing protection and multiple tie down points
- 3/4" diameter matte black steel tube

» 2884842

SPORTSMAN X2 570 '25-26, SPORTSMAN 6X6 570 '25-26, SPORTSMAN TOURING 570 '25-26

DOES NOT WORK WITH KOLPIN STRONGHOLD AUTO-LATCH GUN MOUNT (2884846)

CHAINSAW MOUNT

- Heavy-duty, black powder-coated metal bracket is designed to transport your chain saw securely
- With Lock & Ride technology, it can be secured to the outside of the rack in seconds, without tools, so your chainsaw is within reach at all times
- Accommodates any brand electric chainsaw (sold separately)
- Rubber pads provide cushion and tight fit
- 15 LB weight capacity

» 2890580

SPORTSMAN TOURING 570 '25-26





LR SEMI-RIGID STORAGE BAG

- Fits on either side of rear rack providing riders with more storage options
- Mounts easily with Lock & Ride
- Base is water-resistant to keep your gear dry

» 2890581

SPORTSMAN TOURING 570 '25-26



PASSENGER SEAT BAG

- Straps mount around the rear passenger seat or doubles as a backpack
- Easily add and remove the bag at your convenience
- Semi-rigid compression molded design
- Tapered design allows access to rear storage bin

» 2890060

SPORTSMAN TOURING 570 '25-26

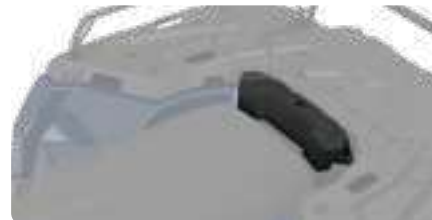

REAR RACK FILLER PLATE

- Fills the space between the driver seat and rear rack when the rear passenger seat is removed
- Fits in Rear Rack Storage Bin when not in use

» 2891000

SPORTSMAN TOURING 570 '25-26



STORAGE BIN NET

- Secure all of your small items and gear
- Made of high quality EPDM rubber

» 2891010

SPORTSMAN TOURING 570 '25-26



FENDER BAG

- Provides easy-access 8.3 liters of storage
- Mounts to the front left fender with HD Velcro®
- Semi-rigid construction and PU laminated EVA material keeps belongings protected from the elements

» 2891193

SPORTSMAN X2 570 '25-26, SPORTSMAN 6X6 570 '25-26, SPORTSMAN TOURING 570 '25-26

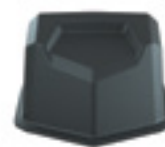

POD BAG

- Keep your essentials in reach with 2 Liters of storage capacity
- Mounts to the top of the light pod with HD Velcro®
- Semi-rigid construction and PU Laminated EVA material keeps belongings protected from the elements
- Compatible with windshields

» 2891194

SPORTSMAN X2 570 '25-26, SPORTSMAN 6X6 570 '25-26, SPORTSMAN TOURING 570 '25-26

WINCHES



PRO SERIES

3,500 LB WINCH

- Adds 3,500 LB of pulling capacity with Auto Stop Technology for plowing applications
- Rapid Rope Recovery recovers open cable 5x as fast as standard mode on other Polaris winches

» 2891610

SPORTSMAN X2 570 '25-26, SPORTSMAN 6X6 570 '25-26, SPORTSMAN TOURING 570 '25-26



3,500 LB WINCH

- Adds 3,500 LBS of pulling capacity with quick and easy installation
- Includes all components required for installation plus 50' of 3/16" premium high-strength synthetic rope

» 2891609

SPORTSMAN X2 570 '25-26, SPORTSMAN 6X6 570 '25-26, SPORTSMAN TOURING 570 '25-26



2,500 LB WINCH

- Adds 2,500 LBS of pulling capacity with quick and easy installation
- Includes all components required for installation plus 50' of 3/16" high-strength steel cable

» 2891608

SPORTSMAN X2 570 '25-26, SPORTSMAN 6X6 570 '25-26, SPORTSMAN TOURING 570 '25-26



LEARN MORE P. 54

450 / 570

850 / XP 1000 XP 1000 S

SCRAMBLER 850 / XP 1000 S

MISCELLANEOUS & YOUTH

WINCHES, FLOWS & TRACKS

LIGHTING

CONNECTED TECHNOLOGY

HUNT & COOLERS

WHEELS & TIRES & TRAILERING



PROTECTION



FRONT TRAIL BUMPER TOP SELLER

- Provides enhanced protection from brush and debris
- Has designated light bar holes and is compatible with winch and Body Armor

» 2884844

SPORTSMAN X2 570 '25-26, SPORTSMAN 6X6 570 '25-26, SPORTSMAN TOURING 570 '25-26



FRONT BUMPER WITH HITCH

- Adds heavy-duty protection with a custom look
- Has designated light bar holes and is compatible with winch and Body Armor
- Standard front receiver hitch for additional functionality

» 2884850

SPORTSMAN X2 570 '25-26, SPORTSMAN 6X6 570 '25-26, SPORTSMAN TOURING 570 '25-26



REAR BUMPER

- Durable 1.25" steel tube with a matte black finish
- Does not block access to the rear storage compartment

» 2890001

SPORTSMAN TOURING 570 '25-26
NOT COMPATIBLE WITH REAR CARGO BOX SUPPORT (2889866) OR REAR CARGO RACK (2890037)



PASSENGER HANDGUARDS

- Two ATV passenger handguards
- Protection for hands in all riding conditions
- Mounting is quick/easy and included

» 2889908

SPORTSMAN TOURING 570 '25-26



NEW REAR GRAB BAR

- Designed to assist in maneuvering the vehicle with ease
- Designated handle to safely and effectively grip when moving the vehicle
- Crafted from high-strength steel to ensure long-lasting performance and reliability
- Quick attachment to the rear of the vehicle

» 2891386

SPORTSMAN TOURING 570 '25-26



NEW FENDER FLARES

- Shields riders from mud, debris and water
- Installs easily with plastic push pin rivets on factory fenders
- Made from durable, textured poly for a rugged finish

» 2891247

SPORTSMAN TOURING 570 '25-26

COMFORT & CONVENIENCE



DRIVER HEATED SEAT

- Plug and play seat installs easily
- Direct replacement for standard seat
- Integrated heat element, wiring harness and control switch

» 2889887

SPORTSMAN TOURING 570 '25-26



PASSENGER HEATED SEAT

- Plug and play seat installs easily
- Direct replacement for standard seat
- Integrated heat element, wiring harness and control switch

» 2889888

SPORTSMAN TOURING 570 '25-26



PASSENGER HEATED GRIPS

- Keeps passenger hands warm in cold weather
- Includes all wiring and high/low switch

» 2889906

SPORTSMAN TOURING 570 '25-26



REAR POWER HARNESS

- Provides power to the rear of your ATV for easy access to hook up and run powered accessories

» 2889886

SPORTSMAN X2 570 '25-26, SPORTSMAN TOURING 570 '25-26



HAND & THUMB WARMER KIT TOP SELLER

- Provides heat to grips and throttle and is easily installed by plugging into pod
- Includes two heated grips and one throttle warmer

» 2885002

SPORTSMAN X2 570 '25-26, SPORTSMAN 6X6 570 '25-26, SPORTSMAN TOURING 570 '25-26



ULTIMATE SERIES HANDGUARD KIT

- Protects riders from wind, snow, ice, branches and other trail debris
- Larger design offers increased level of warmth and protection
- Ultimate Series Handguard Kit includes mounts

■ POLARIS PURSUIT CAMO 2890579-587

■ BLACK 2890579-266

SPORTSMAN X2 570 '25-26, SPORTSMAN 6X6 570 '25-26, SPORTSMAN TOURING 570 '25-26

NOT COMPATIBLE WITH WINDSHIELDS

WINDSHIELDS



TALL 18" CLEAR
2890616



MEDIUM 14" CLEAR
2890617



TALL 18" CLEAR
FOR RIDE COMMAND
EQUIPPED VEHICLES
2890618

WINDSHIELDS

- Lock & Ride technology allows for easy installation and removal in seconds without tools
- Poly windshields are flexible, impact-resistant and provide long-term value over the life of your machine
- Two heights available for whatever coverage you prefer

SIZE	COLOR	PART #
TALL 18"	CLEAR	2890616
MEDIUM 14"	CLEAR	2890617

SPORTSMAN X2 570 '25-26, SPORTSMAN 6X6 570 '25-26, SPORTSMAN TOURING 570 '25-26

FOR RIDE COMMAND EQUIPPED VEHICLES

TALL 18"	CLEAR	2890618
----------	-------	---------

SPORTSMAN X2 570 '25-26, SPORTSMAN 6X6 570 '25-26, SPORTSMAN TOURING 570 '25-26 WITH 7" DISPLAY POWERED BY RIDE COMMAND INSTALLED



MAINTENANCE PARTS & FLUIDS

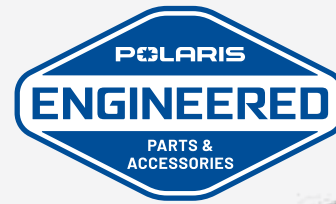

POLARIS ENGINEERED PARTS AND OIL

have been validated and tested extensively, specifically for your vehicle. In order to maintain the peak performance of your Polaris vehicle only use official Polaris Engineered parts and oil.



We're taking the passion of our riders, workers and outdoor enthusiasts to the next level with HD Parts. These Heavy Duty parts are engineered for riders who want greater durability and enhanced performance. HD Parts are designed and tested to handle greater wear and tear under all weather conditions.



A DRIVE BELT

- » 3211113
450, 570
- » **HD** • 3212360
450, 570
- » 3211229
450 EPS (UTILITY), 570 EPS (PREMIUM TRAIL), 570 TOURING, 570 X2, 570 6X6



B BRAKE PADS

- » FRONT & REAR • 2205606
450, 450 EPS (UTILITY), 570, 570 EPS (PREMIUM TRAIL)
- » **HD** FRONT • 2208934
570 TOURING, 570 X2, 570 6X6
- » **HD** REAR • 2208935
570 TOURING, 570 X2, 570 6X6
- » FRONT • 2202413
570 TOURING, 570 X2, 570 6X6
- » REAR • 2202412
570 TOURING, 570 X2, 570 6X6



C OIL FILTER

- » 2520799
- » **HD** • 2522485



D BATTERY

- » 4017419



E AIR FILTER

- » 7083107
- » **HD** • 7083114



F SPARK PLUGS

- » 450 • 3024016
- » 570 • 3022662



LOOKING FOR MORE SERVICE PARTS?

See P. 83 to learn how to find parts for your model.

MAINTENANCE SCHEDULE*

BREAK-IN MAINTENANCE

FIRST 25 HRS | 500 MI / 800 KM

ENGINE OIL & OIL FILTER CHANGE

FRONT GEARCASE CHANGE FLUID

BRAKE PADS INSPECT
REPLACE AS NEEDED

BRAKE FLUID INSPECT
ADD AS NEEDED

TRANSMISSION INSPECT FLUID
ADD AS NEEDED

12 MONTHS

100 HRS | 1,000 MI / 1,600 KM

ENGINE OIL & OIL FILTER CHANGE

AIR FILTER INSPECT
REPLACE AS NEEDED

BRAKE PADS INSPECT
REPLACE AS NEEDED

DRIVE BELT INSPECT
REPLACE AS NEEDED

BATTERY TEST & CLEAN
REPLACE AS NEEDED

FRONT GEARCASE INSPECT

TRANSMISSION FLUID INSPECT

GENERAL LUBRICATION
ALL FITTINGS, PIVOTS, CABLES, ETC.

24 MONTHS

200 HRS | 2,000 MI / 3,200 KM

ENGINE OIL & OIL FILTER CHANGE

BRAKE FLUID CHANGE

AIR FILTER INSPECT
REPLACE AS NEEDED

BRAKE PADS INSPECT
REPLACE AS NEEDED

DRIVE BELT INSPECT
REPLACE AS NEEDED

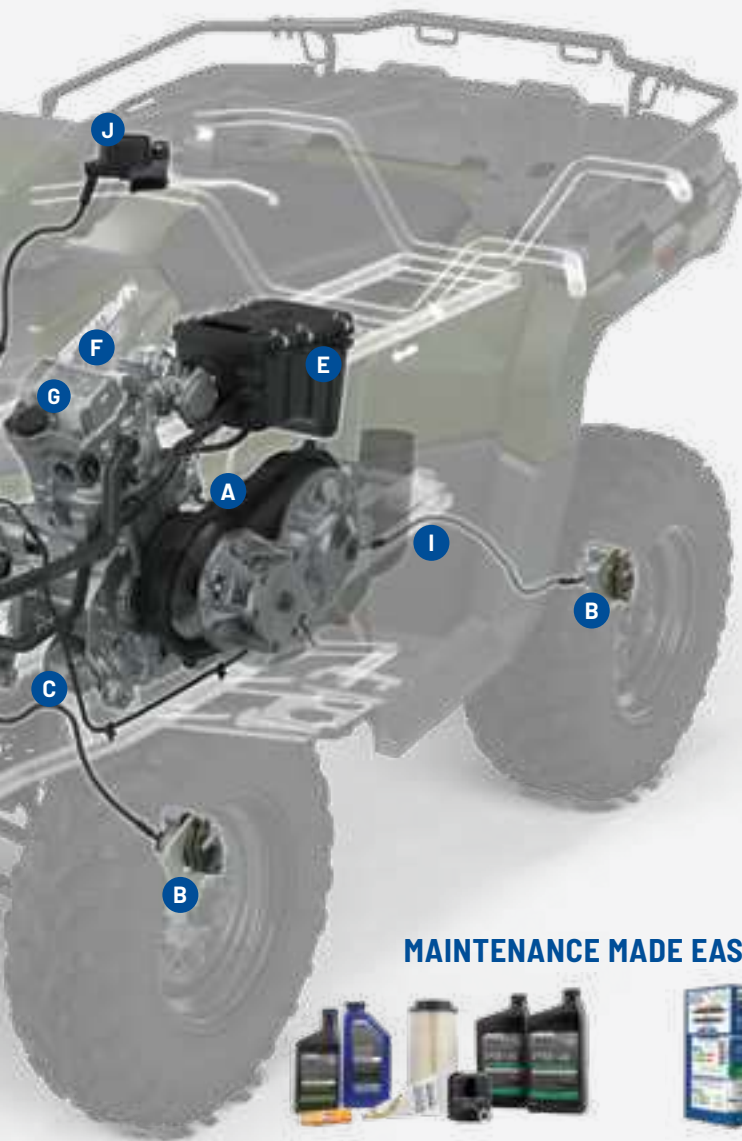

MAINTENANCE MADE EASY



ORV MAINTENANCE KIT

Includes Oil Change Kit, Gearcase Fluids, Air Filter, & Spark Plug
 » 2830549
 570 14-26



OIL CHANGE KITS

2 QT Engine Oil (oil varies by kit), 1 Oil Filter (2540086) & 1 Drain Plug Washer
 » PS-4 • 2877473
 » PS-4 EXTREME • 2890055



G

ENGINE OIL P. 78

- » PS-4 • 1QT • 2876244
- » PS-4 • 1GAL. • 2876245
- » PS-4 EXTREME • 1QT • 2889395
- » PS-4 EXTREME • 1GAL. • 2889396



H

DEMAND DRIVE FLUID

- For front gearcase
- » 1QT • 2877922
 - » 2.5 GAL. • 2877923



I

AGL

- For transmission
- » 1QT • 2878068
 - » 1GAL. • 2878069
 - » EXTREME • 1QT • 2891028



J

DOT 4 BRAKE FLUID

- » 12 OZ • 2872189



ALL-SEASON GREASE TUBE

- » 3 OZ • 2871322
- » 14 OZ • 2871423

Claims made based off testing and performance of Polaris HD Parts against standard OEM parts made by Polaris and competitor brands under normal use. For more information regarding Polaris HD parts including vehicle compatibility, installation and maintenance, please contact your authorized Polaris ORV dealer.

36 MONTHS

300 HRS | 3,000 MI / 4,800 KM

SPARK PLUGS
INSPECT
REPLACE AS NEEDED

BATTERY
TEST & CLEAN
REPLACE AS NEEDED

FRONT GEARCASE
INSPECT

TRANSMISSION FLUID
INSPECT

GENERAL LUBRICATION
ALL FITTINGS, PIVOTS, CABLES, ETC.

ENGINE OIL & OIL FILTER
CHANGE

AIR FILTER
INSPECT
REPLACE AS NEEDED

BRAKE PADS
INSPECT
REPLACE AS NEEDED

DRIVE BELT
INSPECT
REPLACE AS NEEDED

BATTERY
TEST & CLEAN
REPLACE AS NEEDED

FRONT GEARCASE
INSPECT

TRANSMISSION FLUID
INSPECT

GENERAL LUBRICATION
ALL FITTINGS, PIVOTS, CABLES, ETC.

FOR A COMPLETE MAINTENANCE SCHEDULE, CHECK YOUR OWNER'S MANUAL





TRAIL RIDING PACKAGE

SCAN TO SHOP THIS PACKAGE



- 2890579-266 Ultimate Series Handguard Kit P. 45
- 2885002 Hand & Thumb Warmer Kit P. 45
- 2883128 RIGID® D-Series Pro Driving LED Light P. 60



- 2882320 LED Light Bar Wiring Harness P. 61
- 2879860 LED Y-Harness P. 61



HUNT PACKAGE

SCAN TO SHOP THIS PACKAGE



- 2890617  Medium 14" Clear Windshield P. 42
- 2882023 Ultimate Series Rear Rack Extender 4" P. 43
- 2890581  Semi-Rigid Storage Bag P. 44
- 2885002 Hand & Thumb Warmer Kit P. 45



- 2883123 RIGID® SR-Series 10" Combo LED Light P. 61
- 2882320 LED Light Bar Wiring Harness P. 61
- 2882426 Kolpin Stronghold Gun Boot L P. 64
- 2884846 Kolpin Stronghold Auto-Latch Mount P. 64
- 2884119  Rhino Grip Pro P. 65



LANDOWNER PACKAGE

SCAN TO SHOP THIS PACKAGE





- 2890617  Medium 14" Clear Windshield P. 42
- 2890877  Open Cargo Box P. 44



WINTER PACKAGE

SCAN TO SHOP THIS PACKAGE



- | | |
|--|--|
| <ul style="list-style-type: none"> 2890876  Rear Cargo Box P. 44 2885002 Hand & Thumb Warmer Kit P. 45 2890616  Tall 18" Clear Windshield P. 42 2881423 Integrated Plow Mount Frame Attachment P. 57 | <ul style="list-style-type: none"> 2879630 Steel ATV Plow Frame P. 57 2880269 Pro Series Plow Blade - 66" Poly P. 57 2883123 RIGID® SR-Series 10" Combo LED Light P. 61 2882320 LED Light Bar Wiring Harness P. 61 |
|--|--|



WINCHES



LEARN MORE P. 54



PRO SERIES

3,500 LB WINCH

» 2891613

SPORTSMAN 850 '12-26, SPORTSMAN XP 1000 '15-26,
SPORTSMAN TOURING XP 1000 '15-26,
SPORTSMAN TOURING 850 '15-26

» 2891614

SPORTSMAN XP 1000 S '20-26

3,500 LB WINCH

» 2891612

SPORTSMAN 850 '12-26, SPORTSMAN XP 1000 '15-26,
SPORTSMAN TOURING XP 1000 '15-26,
SPORTSMAN TOURING 850 '15-26

2,500 LB WINCH

» 2891611

SPORTSMAN 850 '12-26, SPORTSMAN XP 1000 '15-26,
SPORTSMAN TOURING XP 1000 '15-26,
SPORTSMAN TOURING 850 '15-26

NEED A PLOW? P. 56

WINDSHIELDS

LR WINDSHIELDS

- Provides enhanced protection from the elements
- Easily installs and removes without tools utilizing Lock & Ride technology
- Improved mounting system for easier and quicker attachment and detachment



TALL 18" CLEAR
2890616



MEDIUM 14" CLEAR
2890617



TALL 18" CLEAR
FOR RIDE COMMAND
EQUIPPED VEHICLES
2890618

SIZE	COLOR	PART #
TALL 18"	CLEAR	2890616
MEDIUM 14"	CLEAR	2890617

SPORTSMAN XP 1000 S '21-26, SPORTSMAN XP 1000 '21-26, SPORTSMAN 850 '21-26

FOR RIDE COMMAND EQUIPPED VEHICLES

TALL 18"	CLEAR	2890618
----------	-------	---------

SPORTSMAN XP 1000 '22-26, SPORTSMAN 850 '22-26
WITH 7" DISPLAY POWERED BY RIDE COMMAND INSTALLED

RACKS



ULTIMATE SERIES RACK EXTENDER 4"

» FRONT • 2882022

SPORTSMAN 850/1000 '17-26,
SPORTSMAN XP 1000 S '20-26

» REAR • 2882023

SPORTSMAN 850/1000 '17-26,
SPORTSMAN XP 1000 S '20-26
FITS WITH REAR CARGO BOX (2890876)



ULTIMATE SERIES RACK EXTENDER 7"

» FRONT • 2882024

SPORTSMAN 850/1000 '17-26,
SPORTSMAN XP 1000 S '20-26

» REAR • 2882025

SPORTSMAN 850/1000 '17-26,
SPORTSMAN XP 1000 S '20-26
DOES NOT FIT WITH REAR CARGO BOX (2890876)



FRONT RACK EXTENDER

» 2879890

SPORTSMAN 850/1000 TOURING '10-26
DOES NOT FIT WITH FRONT CARGO BOX (2877951)



ULTIMATE SERIES MOVABLE TIE-DOWN POINTS

- Comes as pair

» FRONT & REAR • 2882270

SPORTSMAN 850/1000 '17-26



ULTIMATE SERIES STEEL RACK

» FRONT • 2883257

SPORTSMAN 850/1000 '17-26,
SPORTSMAN XP 1000 S '20-26

» REAR • 2883258

SPORTSMAN 850/1000 '17-26,
SPORTSMAN XP 1000 S '20-26

PROTECTION



ULTIMATE SERIES BODY ARMOR

- Securely mounts to Ultimate Series Front Bumper (2882020)
- Comes as pair

» 2882090

SPORTSMAN 850/1000 '17-26
DOES NOT WORK WITH KOLPIN STRONGHOLD GUN BOOT XL (2882036)



ULTIMATE SERIES BUMPER TOP SELLER

- Quick installation to the integrated mounting tubes on the vehicle using wedge-style expansion anchor mounts
- Attach the Ultimate Series Body Armor to the Front Bumper to provide the ultimate protection for the front fenders

» FRONT • 2882020

SPORTSMAN 850/1000 '17-26,
SPORTSMAN XP 1000 S '20-26

» REAR • 2882583

SPORTSMAN 850/1000 '17-26,
SPORTSMAN XP 1000 S '20-26



TOURING XP BUMPER

- Adds heavy-duty protection and a custom look

» FRONT • 2878709

SPORTSMAN 850/1000 TOURING '10-26

» REAR • 2878324

SPORTSMAN 850/1000 TOURING '10-26



STORAGE



REAR CARGO BOX

- Increase your storage with an extra 85 QTS of dry, dust-proof storage
- Mounts easily with Lock & Ride to the rear rack and is compatible with rack extenders and gun mount
- Includes 2 padlock locations

» 2890876

SPORTSMAN 850/1000 '17-26, SPORTSMAN XP 1000 S '20-26
WILL NOT FIT WHEN ULTIMATE SERIES STEEL RACK IS INSTALLED



OPEN CARGO BOX

- Increase your storage with an extra 88 QTS of convenient storage space
- Mounts easily with Lock & Ride to the rear rack and is compatible with rack extenders and gun mount
- Holds 2, 5-gallon buckets with integrated grab handle to make it easy to carry and transport cargo
- 12 convenient tie-down locations to secure cargo
- Includes 2 padlock locations

» 2890877

SPORTSMAN 850/1000 '17-26, SPORTSMAN XP 1000 S '20-26
WILL NOT FIT WHEN ULTIMATE SERIES STEEL RACK IS INSTALLED



REAR COOLER BOX

- Increase your storage with an extra 46 QTS of weather-resistant cooler storage space
- Mounts easily with Lock & Ride to the rear rack and is compatible with rack extenders and gun mount
- Integrated bottle opener and 2 padlock locations

» 2890879

SPORTSMAN 850/1000 '17-26, SPORTSMAN XP 1000 S '20-26
WILL NOT FIT WHEN ULTIMATE SERIES STEEL RACK IS INSTALLED



POD BAG

- Keep your essentials in reach with 2 liters of storage capacity
- Mounts to the top of the light pod with HD Velcro®
- Semi-rigid construction and PU laminated EVA material keeps belongings protected from the elements
- Compatible with windshields

» 2891194

SPORTSMAN 850/1000 '21-26



SEMI-RIGID STORAGE BAG

- Fits on either side of rear rack providing riders with more storage options
- Mounts easily with Lock & Ride
- Base is water-resistant to keep your gear dry

» 2890581

SPORTSMAN 850/1000 '17-26, SPORTSMAN XP 1000 S '20-26



ULTIMATE SERIES READY PACK

- Keep your trail essentials at the ready with this easy-to-access, weather-resistant storage compartment

» 2882271

SPORTSMAN 850/1000 '17-26



FRONT CARGO BOX

» 2877951

SPORTSMAN 850/1000 TOURING '10-26
FRONT RACK EXTENDER CANNOT BE INSTALLED AT THE SAME TIME AS FRONT CARGO BOX



REAR STORAGE BOX

» 2878000

SPORTSMAN 850/1000 TOURING '10-26
SLIGHT INTERFERENCE WITH SPORTSMAN TOURING 850/850 '11-14 PASSENGER HANDLES
DOES NOT FIT '21 TOURING MODELS



COMFORT



HANDLEBAR MOUNTED MIRRORS TOP SELLER

- Enhances visibility of what's behind you for added safety
- Sold as a pair

» 2890578

SPORTSMAN 850/1000 TOURING '10-26, SPORTSMAN 850/1000 '09-26,
SPORTSMAN XP1000 S '20-26



HAND & THUMB WARMER KIT TOP SELLER

- Provides heat to grips and throttle and is easily installed by plugging into pod
- Includes two heated grips and one throttle warmer

» KIT • 2885002

SPORTSMAN XP1000 S '20-26, SPORTSMAN 850/1000 '15-26, SPORTSMAN TOURING 850/1000 '15-26

» JUMPER HARNESS • 2890685

REQUIRED FOR THE FOLLOWING MODELS: SPORTSMAN XP1000 S '20, SPORTSMAN 850/1000 '15-20,
SPORTSMAN TOURING 850/1000 '15-26



ULTIMATE SERIES HANDGUARD KIT

- Larger design offers increased protects from wind, snow, ice, branches and other trail debris
- Mounts included

■ POLARIS PURSUIT CAMO 2890579-587

■ BLACK 2890579-266

SPORTSMAN 850/1000 TOURING '10-26,
SPORTSMAN 850/1000 '09-26, SPORTSMAN XP1000 S '20-26
NOT COMPATIBLE WITH WINDSHIELDS

HANDGUARDS

- Handguard Mount (2889341) is required when installing Polaris Handguards
- SPORTSMAN 850/1000 TOURING '10-26, SPORTSMAN 850/1000 '09-26, SPORTSMAN XP1000 S '20-26
NOT COMPATIBLE WITH WINDSHIELDS

□ BRIGHT WHITE 2876883

■ BLACK TOP SELLER 2876846

■ INDY RED 2876845

» MOUNT • 2889341



DO MORE



PLOWS P. 56



WHEELS & TIRES P. 68



LIGHTING P. 60



HUNT P. 64

MAINTENANCE PARTS & FLUIDS

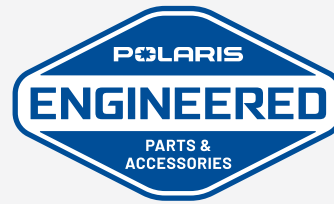

POLARIS ENGINEERED PARTS AND OIL have been validated and tested extensively, specifically for your vehicle. In order to maintain the peak performance of your Polaris vehicle only use official Polaris Engineered parts and oil.



We're taking the passion of our riders, workers and outdoor enthusiasts to the next level with HD Parts. These Heavy Duty parts are engineered for riders who want greater durability and enhanced performance. HD Parts are designed and tested to handle greater wear and tear under all weather conditions.



A DRIVE BELT

» 3211160

850, XP 1000, 850 TOURING,
XP 1000 TOURING

» 3212329

XP 1000 S

» 3211203

850 / XP 1000 MUD EDITION

» **HD** • 3212331

850, XP 1000, 850 TOURING,
XP 1000 TOURING, XP 1000 S



B BRAKE PADS

» FRONT & REAR • 2205606

850, XP 1000

» FRONT • 2205606

XP 1000 S

» REAR • 2208936

XP 1000 S

» FRONT & REAR • 2207835

850 / XP 1000 MUD EDITION



C OIL FILTER

» 2520799

» **HD** • 2522485



D BATTERY

» 4014609



E AIR FILTER

» 7083107

» **HD** • 7083114



F SPARK PLUGS

» 3022438

850, 850 TOURING

» 3022553

XP 1000, XP 1000 S, XP 1000 TOURING

LOOKING FOR MORE SERVICE PARTS?

See P. 83 to learn how to find parts for your model.

MAINTENANCE SCHEDULE*

BREAK-IN MAINTENANCE

FIRST 25 HRS | 250 MI / 400 KM

ENGINE OIL & OIL FILTER
CHANGE

TRANSMISSION
CHANGE FLUID

AIR FILTER
INSPECT
REPLACE AS NEEDED

FRONT & REAR GEARCASE
INSPECT FLUID

6 MONTHS

50 HRS | 500 MI / 800 KM

DRIVE BELT
INSPECT
REPLACE AS NEEDED

AIR FILTER
INSPECT
REPLACE AS NEEDED

BATTERY
TEST & CLEAN
REPLACE AS NEEDED

GENERAL LUBRICATION
ALL FITTINGS, PIVOTS,
CABLES, ETC.

12 MONTHS

100 HRS | 1,000 MI / 1,600 KM

ENGINE OIL & OIL FILTER
CHANGE

FRONT & REAR GEARCASE
CHANGE FLUID

AIR FILTER
INSPECT
REPLACE AS NEEDED

BRAKE PADS
INSPECT
REPLACE AS NEEDED

DRIVE BELT
INSPECT
REPLACE AS NEEDED

18 MONTHS

150 HRS | 1,500 MI / 2,400 KM

AIR FILTER
INSPECT
REPLACE AS NEEDED

DRIVE BELT
INSPECT
REPLACE AS NEEDED

BATTERY
TEST & CLEAN
REPLACE AS NEEDED

GENERAL LUBRICATION
ALL FITTINGS, PIVOTS,
CABLES, ETC.

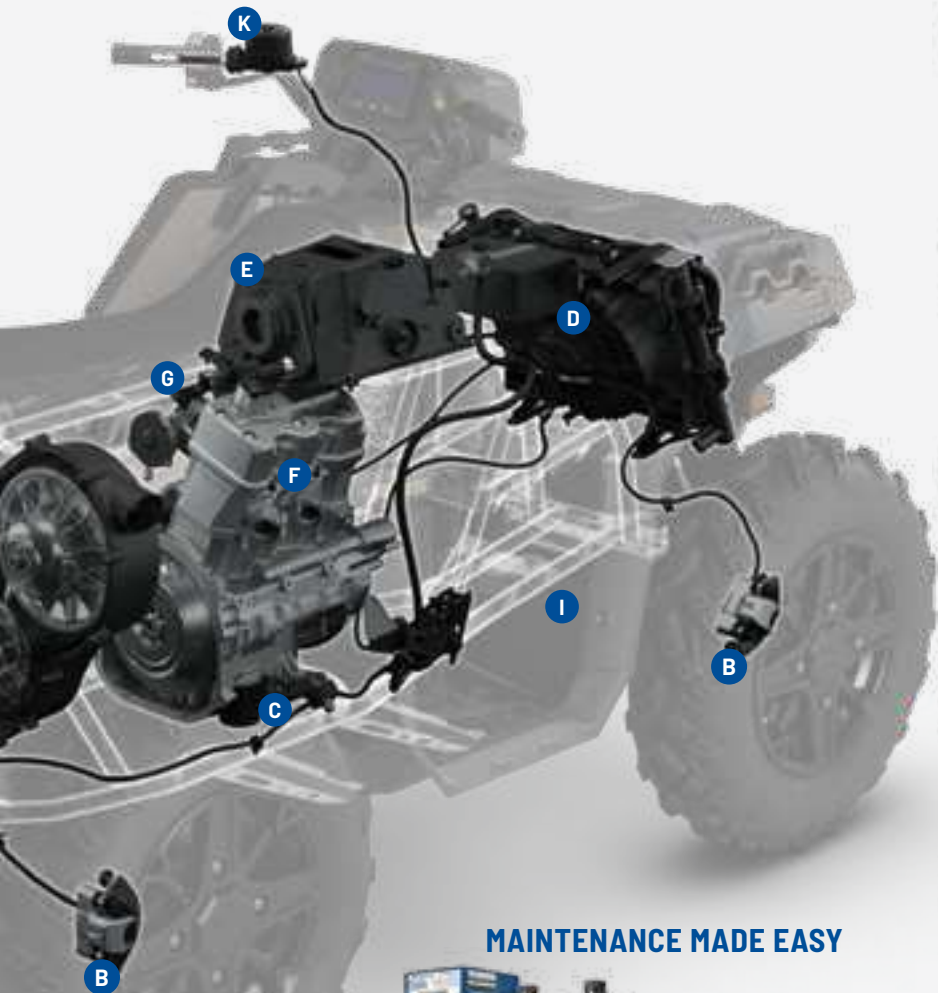

G
ENGINE OIL P. 78
» PS-4 • 1QT • 2876244
» PS-4 • 1 GAL. • 2876245
» PS-4 EXTREME • 1QT • 2889395
» PS-4 EXTREME • 1 GAL. • 2889396



H
ANGLE DRIVE FLUID
For rear gearcase
» 1QT • 2889280



I
DEMAND DRIVE FLUID
For front gearcase
» 1QT • 2877922
» 2.5 GAL. • 2877923



J
AGL
For transmission
» 1QT • 2878068
» 1 GAL. • 2878069
» EXTREME • 1QT • 2891028



K
DOT 4 BRAKE FLUID
» 12 OZ • 2872189

MAINTENANCE MADE EASY



OIL CHANGE KITS
2 QT Engine Oil (oil varies by kit), 1 Oil Filter (2540086) & 1 Drain Plug Washer
» PS-4 • 2877473
» PS-4 EXTREME • 2890055

ALL-SEASON GREASE TUBE
» 3 OZ • 2871322
» 14 OZ • 2871423

Claims made based off testing and performance of Polaris HD Parts against standard OEM parts made by Polaris and competitor brands under normal use. For more information regarding Polaris HD parts including vehicle compatibility, installation and maintenance, please contact your authorized Polaris ORV dealer.

24 MONTHS

200 HRS | 2,000 MI / 3,200 KM

- ENGINE OIL & OIL FILTER CHANGE**
- FRONT & REAR GEARCASE CHANGE FLUID**
- BRAKE FLUID CHANGE**
- AIR FILTER INSPECT**
REPLACE AS NEEDED
- BRAKE PADS INSPECT**
REPLACE AS NEEDED
- DRIVE BELT INSPECT**
REPLACE AS NEEDED
- ALTERNATOR BELT INSPECT**
REPLACE AS NEEDED
- SPARK PLUGS INSPECT**
REPLACE AS NEEDED
- BATTERY TEST & CLEAN**
REPLACE AS NEEDED
- TRANSMISSION INSPECT FLUID**
- GENERAL LUBRICATION ALL FITTINGS, PIVOTS, CABLES, ETC.**

30 MONTHS

250 HRS | 2,500 MI / 4,000 KM

- AIR FILTER INSPECT**
REPLACE AS NEEDED
- DRIVE BELT INSPECT**
REPLACE AS NEEDED
- BATTERY TEST & CLEAN**
REPLACE AS NEEDED
- GENERAL LUBRICATION ALL FITTINGS, PIVOTS, CABLES, ETC.**

36 MONTHS

300 HRS | 3,000 MI / 4,800 KM

- ENGINE OIL & OIL FILTER CHANGE**
- FRONT & REAR GEARCASE CHANGE FLUID**
- AIR FILTER INSPECT**
REPLACE AS NEEDED
- BRAKE PADS INSPECT**
REPLACE AS NEEDED
- DRIVE BELT INSPECT**
REPLACE AS NEEDED
- ALTERNATOR BELT INSPECT**
REPLACE AS NEEDED
- SPARK PLUGS INSPECT**
REPLACE AS NEEDED
- BATTERY TEST & CLEAN**
REPLACE AS NEEDED
- TRANSMISSION INSPECT FLUID**
- GENERAL LUBRICATION ALL FITTINGS, PIVOTS, CABLES, ETC.**

FOR A COMPLETE MAINTENANCE SCHEDULE, CHECK YOUR OWNER'S MANUAL



*This is a sample maintenance schedule. Please reference and use your owners manual for full maintenance and vehicle care.



WINCHES



LEARN MORE P. 54



PRO SERIES

3,500 LB WINCH

» 2891614
SCRAMBLER XP 1000 S '20-26

» 2891613
SCRAMBLER 850 '14-26,
SCRAMBLER XP 1000 '14-18

3,500 LB WINCH

» 2891612
SCRAMBLER 850 '14-26, SCRAMBLER XP 1000 '14-18

2,500 LB WINCH

» 2891611
SCRAMBLER 850 '14-26, SCRAMBLER XP 1000 '14-18

RACKS/STORAGE



LARGE REAR RACK

» 2879139
SCRAMBLER XP 1000 S '20-26, SCRAMBLER XP 1000 '14-18, SCRAMBLER 850 '14-26
NOT COMPATIBLE WITH OGIO® BAG (2879925)



OGIO® BAG

» 2879925
SCRAMBLER XP 1000 S '20-26, SCRAMBLER XP 1000 '14-18, SCRAMBLER 850 '14-26
NOT COMPATIBLE WITH LARGE REAR RACK (2879139)



PROTECTION

ULTIMATE SPORT SERIES FRONT BUMPER

» 2883595-458

SCRAMBLER XP 1000 S '20-26



COMFORT



HANDGUARD

- Handguard Mount (2889341) is required when installing Polaris Handguards
- Does not fit with windshields

<input type="checkbox"/>	BRIGHT WHITE	2876883
<input checked="" type="checkbox"/>	BLACK <small>TOP SELLER</small>	2876846
<input type="checkbox"/>	INDY RED	2876845

» 2889341 • MOUNT



SCRAMBLER XP 1000 S '20-26,
SCRAMBLER 850 '14-26,
SCRAMBLER XP 1000 '14-18



ULTIMATE SERIES HANDGUARD KIT

- Protects riders from wind, snow, ice, branches and other trail debris
- Larger design offers increased level of warmth and protection
- Ultimate Series Handguard Kit includes mounts

» 2890579-266

SCRAMBLER XP 1000 S '20-26, SCRAMBLER 850 '14-26, SCRAMBLER XP 1000 '14-18
NOT COMPATIBLE WITH WINDSHIELDS

MAINTENANCE PARTS & FLUIDS



POLARIS ENGINEERED PARTS AND OIL have been validated and tested extensively, specifically for your vehicle. In order to maintain the peak performance of your Polaris vehicle only use official Polaris Engineered parts and oil.



We're taking the passion of our riders, workers and outdoor enthusiasts to the next level with HD Parts. These Heavy Duty parts are engineered for riders who want greater durability and enhanced performance. HD Parts are designed and tested to handle greater wear and tear under all weather conditions.

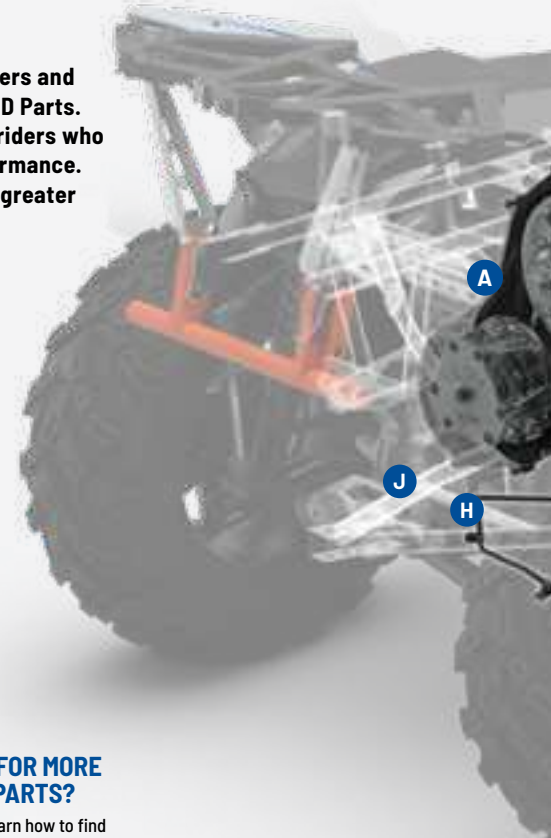

A DRIVE BELT

- » 3211160
SCRAMBLER 850
- » 3212329
SCRAMBLER XP 1000 S
- » **HD** • 3212331



B BRAKE PADS

- » FRONT & REAR • 2205606
SCRAMBLER 850
- » FRONT • 2205606
SCRAMBLER XP 1000 S
- » REAR • 2208936
SCRAMBLER XP 1000 S



C OIL FILTER

- » 2520799
- » **HD** • 2522485



D BATTERY

- » 4014609



E AIR FILTER

- » 7083107
- » **HD** • 7083114



F SPARK PLUGS

- » 3022438
SCRAMBLER 850
- » 3022553
SCRAMBLER XP 1000 S

LOOKING FOR MORE SERVICE PARTS?

See P. 83 to learn how to find parts for your model.

MAINTENANCE SCHEDULE*

BREAK-IN MAINTENANCE

FIRST 25 HRS | 250 MI / 400 KM

- ENGINE OIL & OIL FILTER**
CHANGE
- TRANSMISSION**
CHANGE FLUID
- FRONT & REAR GEARCASE**
CHANGE FLUID
- AIR FILTER**
INSPECT
REPLACE AS NEEDED

6 MONTHS

50 HRS | 500 MI / 800 KM

- AIR FILTER**
INSPECT
REPLACE AS NEEDED
- BRAKE PADS**
INSPECT
REPLACE AS NEEDED
- DRIVE BELT**
INSPECT
REPLACE AS NEEDED
- BATTERY**
TEST & CLEAN
REPLACE AS NEEDED
- GENERAL LUBRICATION**
ALL FITTINGS,
PIVOTS, CABLES, ETC.

12 MONTHS

100 HRS | 1,000 MI / 1,600 KM

- ENGINE OIL & OIL FILTER**
CHANGE
- TRANSMISSION**
CHANGE FLUID
- FRONT & REAR GEARCASE**
CHANGE FLUID
- AIR FILTER**
INSPECT
REPLACE AS NEEDED
- BRAKE PADS**
INSPECT
REPLACE AS NEEDED
- SPARK PLUGS**
INSPECT
REPLACE AS NEEDED
- GENERAL LUBRICATION**
ALL FITTINGS, PIVOTS,
CABLES, ETC.

18 MONTHS

150 HRS | 1,500 MI / 2,400 KM

- AIR FILTER**
INSPECT
REPLACE AS NEEDED
- BRAKE PADS**
INSPECT
REPLACE AS NEEDED
- DRIVE BELT**
INSPECT
REPLACE AS NEEDED
- BATTERY**
TEST & CLEAN
REPLACE AS NEEDED
- GENERAL LUBRICATION**
ALL FITTINGS,
PIVOTS, CABLES, ETC.

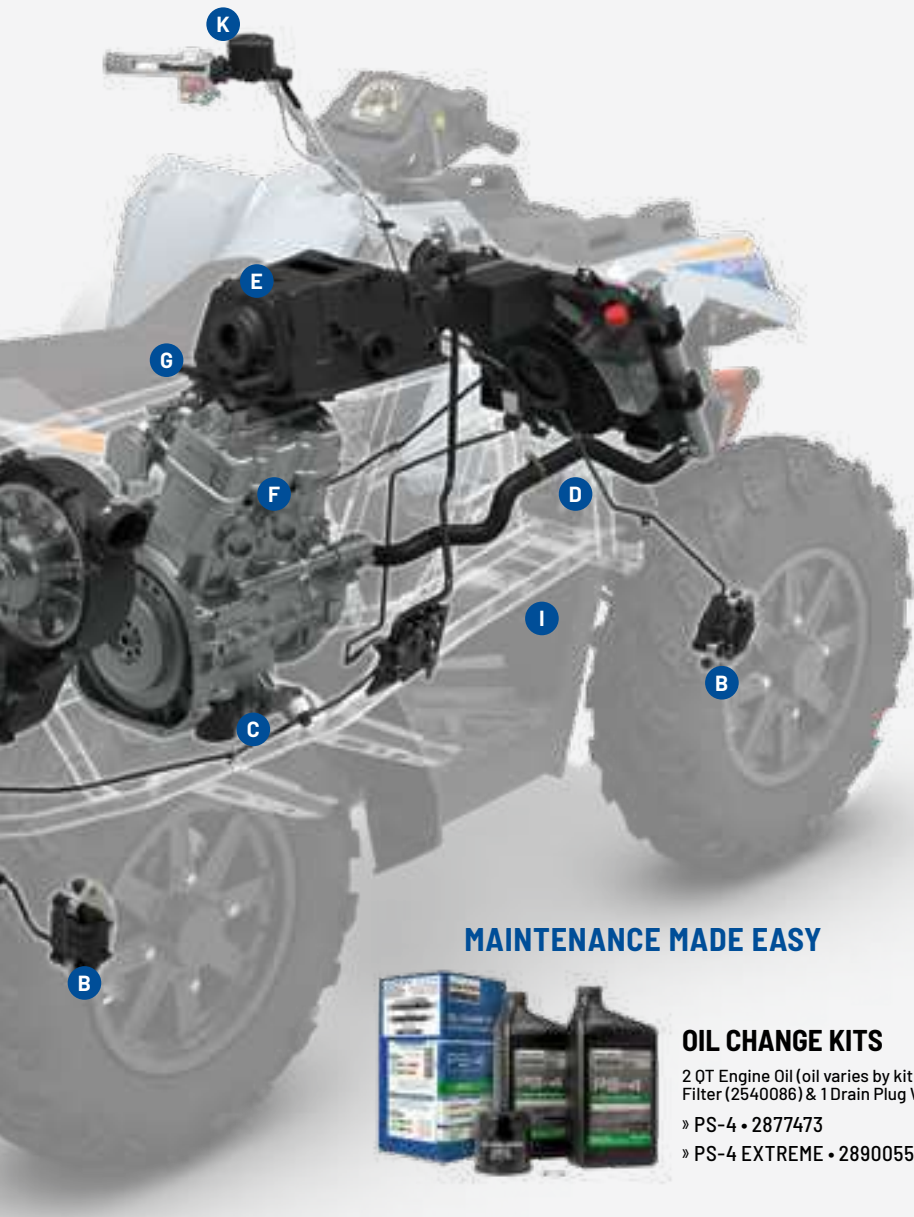

MAINTENANCE MADE EASY



OIL CHANGE KITS

2 QT Engine Oil (oil varies by kit), 1 Oil Filter (2540086) & 1 Drain Plug Washer

- » PS-4 • 2877473
- » PS-4 EXTREME • 2890055



G
ENGINE OIL P. 78

- » PS-4 • 1 QT • 2876244
- » PS-4 • 1 GAL. • 2876245
- » PS-4 EXTREME • 1 QT • 2889395
- » PS-4 EXTREME • 1 GAL. • 2889396



H
ANGLE DRIVE FLUID

For rear gearcase

- » 1 QT • 2889280



I
DEMAND DRIVE FLUID

For front gearcase

- » 1 QT • 2877922
- » 2.5 GAL. • 2877923



J
AGL

For transmission

- » 1 QT • 2878068
- » 1 GAL. • 2878069
- » EXTREME • 1 QT • 2891028



K
DOT 4 BRAKE FLUID

- » 12 OZ • 2872189



ALL-SEASON GREASE TUBE

- » 3 OZ • 2871322
- » 14 OZ • 2871423

Claims made based off testing and performance of Polaris HD Parts against standard OEM parts made by Polaris and competitor brands under normal use. For more information regarding Polaris HD parts including vehicle compatibility, installation and maintenance, please contact your authorized Polaris ORV dealer.

24 MONTHS

- 200 HRS | 2,000 MI / 3,200 KM
- ENGINE OIL & OIL FILTER CHANGE**
 - TRANSMISSION CHANGE FLUID**
 - FRONT & REAR GEARCASE CHANGE FLUID**
 - AIR FILTER INSPECT**
REPLACE AS NEEDED
 - BRAKE PADS / BRAKE FLUID INSPECT / CHANGE**
REPLACE AS NEEDED / NA
 - SPARK PLUGS INSPECT**
REPLACE AS NEEDED
 - GENERAL LUBRICATION**
ALL FITTINGS, PIVOTS, CABLES, ETC.

30 MONTHS

- 250 HRS | 2,500 MI / 4,000 KM
- AIR FILTER INSPECT**
REPLACE AS NEEDED
 - BRAKE PADS INSPECT**
REPLACE AS NEEDED
 - DRIVE BELT INSPECT**
REPLACE AS NEEDED
 - BATTERY TEST & CLEAN**
REPLACE AS NEEDED
 - GENERAL LUBRICATION**
ALL FITTINGS, PIVOTS, CABLES, ETC.

36 MONTHS

- 300 HRS | 3,000 MI / 4,800 KM
- ENGINE OIL & OIL FILTER CHANGE**
 - TRANSMISSION CHANGE FLUID**
 - FRONT & REAR GEARCASE CHANGE FLUID**
 - AIR FILTER INSPECT**
REPLACE AS NEEDED
 - BRAKE PADS INSPECT**
REPLACE AS NEEDED
 - SPARK PLUGS INSPECT**
REPLACE AS NEEDED
 - GENERAL LUBRICATION**
ALL FITTINGS, PIVOTS, CABLES, ETC.

FOR A COMPLETE MAINTENANCE SCHEDULE, CHECK YOUR OWNER'S MANUAL



*This is a sample maintenance schedule. Please reference and use your owners manual for full maintenance and vehicle care.

MISCELLANEOUS

ACCESSORIES



QUICKTAP BATTERY POSTS

- Easy-to-access terminal posts give you quick access to the battery power
 - Ideal for charging your battery, powering a temporary accessory, or when you need to offer an unexpected jump-start
 - Connection posts feature covers to protect terminals when not in use
- » 2882110



ATV LICENSE PLATE

- Includes numbers and letters
- » 2873270



RECOVERY STRAP

- 2" x 30' (18,000 LBS)
 - Comes with carry bag
- » 2884033

TRAILERING AND ADDITIONAL STRAPS

P. 74

YOUTH ATV

2025 OUTLAW 70 EFI

The perfect first all-terrain vehicle for kids starting at 6 years and older.



FRONT BUMPER

- Provides enhanced protection from brush and other debris on the trail
- » 2884567
OUTLAW 70 EFI '21-25



WINDSHIELD - POLY

- Added wind and hand protection with a durable poly design
- » 2885005
OUTLAW 70 EFI '21-25



REAR BUMPER

- Protect the rear of your youth ATV on the trails
- » 2884778
OUTLAW 70 EFI '21-25



REAR STORAGE BAG

- Convenient storage that easily connects to the rear rack
- » 2884555
OUTLAW 70 EFI '21-25

SPORTSMAN YOUTH MAINTENANCE PARTS & FLUIDS

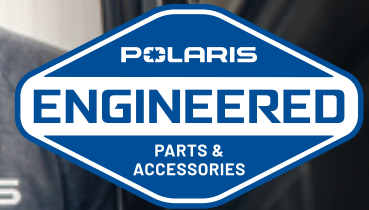

POLARIS ENGINEERED PARTS AND OIL have been validated and tested extensively, specifically for your vehicle. In order to maintain the peak performance of your Polaris vehicle only use official Polaris Engineered parts and oil.



DRIVE BELT

- » 3023904
OUTLAW 70 EFI
- » 0453455
OUTLAW 110 EFI, SPORTSMAN 110
- » 0452496
PHOENIX 200



BRAKE PADS

- » FRONT/REAR • 2208176
OUTLAW 70 EFI
- » FRONT • 0455315
OUTLAW 110 EFI, SPORTSMAN 110
- » REAR • 0455441
OUTLAW 110 EFI, SPORTSMAN 110
- » FRONT • 0454664
PHOENIX 200



OIL FILTER

- » 3023869
OUTLAW 70 EFI
- » 0452462
PHOENIX 200



BATTERY

- » 4010678
OUTLAW 70 EFI
- » 4011181
OUTLAW 110 EFI, SPORTSMAN 110
- » 4011434
PHOENIX 200



AIR FILTER

- » 7082513
OUTLAW 70 EFI
- » 0454620
OUTLAW 110 EFI, SPORTSMAN 110
- » 1253355
PHOENIX 200



SPARK PLUGS

- » 3023835
OUTLAW 70 EFI
- » 0453034
OUTLAW 110 EFI
- » 3023835
PHOENIX 200



ENGINE OIL

SEE P. 78 FOR DETAILS



ANGLE DRIVE FLUID

- » 1QT • 2889280
PHOENIX 200



AGL

- » 1QT • 2878068
- » 1 GAL. • 2878069
- » EXTREME • 1QT • 2891028



DOT 4 BRAKE FLUID

- » 12 OZ • 2872189



ALL-SEASON GREASE TUBE

- » 3 OZ • 2871322
- » 14 OZ • 2871423

MAINTENANCE SCHEDULE*

BREAK-IN MAINTENANCE	1 MONTH	6 MONTHS	8 MONTHS	12 MONTHS
FIRST 10 HRS 100 MI / 160 KM	20 HRS 200 MI / 320 KM	50 HRS 500 MI / 800 KM	60 HRS 700 MI / 1000 KM	100 HRS 1000 MI / 1600 KM
ENGINE OIL & FILTER CHANGED	ENGINE OIL & FILTER CHANGE	BRAKE PADS INSPECT REPLACE AS NEEDED	AIR FILTER INSPECT & CLEAN REPLACE AS NEEDED	TRANSMISSION OIL CHANGE
TRANSMISSION OIL CHANGE	BATTERY CLEAN & TEST	DRIVE BELT INSPECT REPLACE AS NEEDED	SPARK PLUG INSPECT & CLEAN REPLACE AS NEEDED	DRIVE BELT INSPECT REPLACE AS NEEDED
AIR FILTER INSPECT & CLEAN REPLACE AS NEEDED		GENERAL LUBRICATION ALL FITTINGS, PIVOTS, CABLES, ETC.		
DRIVE CHAIN ADJUST & LUBRICATE				

*This is a sample maintenance schedule. Please reference and use your owners manual for full maintenance and vehicle care.

FOR A COMPLETE
MAINTENANCE
SCHEDULE, CHECK
YOUR OWNER'S MANUAL



ACCESSORIES

450 / 570

850 / XP 1000
XP 1000 S

SCRAMBLER 850 /
XP 1000 S

MISCELLANEOUS
& YOUTH

WINCHES, PLOWS
& TRACKS

LIGHTING

CONNECTED
TECHNOLOGY

HUNT & COOLERS

WHEELS & TIRES
& TRAILERING

WINCHES

ADD A PLOW
P. 56

DEPENDABLE. TOUGH. BUILT FOR THE OFF-ROAD.

A Polaris Engineered winch is designed to help you get the job done right, get you on your way faster and prepare you for the unexpected.

WHY POLARIS?

Polaris Off-Road vehicles are engineered with designated mounting points and wiring for seamless install of Polaris Engineered winches.



TESTED **1,200+**
PULLS AT MAX LOAD



BUILT TO WITHSTAND
-20° F TEMPERATURES



OPERATES
FULLY SUBMERGED



MILITARY
TESTED & APPROVED



TOP SELLER
REPLACEMENT SYNTHETIC ROPE

» 2,500 LB • 2878888



REPLACEMENT STEEL CABLE

• 50'
» 2,500 LB • 2878890

FEATURES & BENEFITS

ALL POLARIS ENGINEERED WINCHES COME WITH:



WARRANTY

- ✓ **INTEGRATED WIRING, MOUNT, PREASSEMBLED**
- ✓ **HOOK WITH STRAP**
- ✓ **CUT STEEL GEARS & SEALED DRIVETRAIN**
- ✓ **SEALED PERMANENT MAGNET MOTOR**

RAPID ROPE RECOVERY

5x
FASTER

Retrieve cable 5x as fast as standard mode on other Polaris winches. Get back to riding or complete your task quicker.

1. Set winch dial to N (Neutral) to manually pull the rope out and secure the hook to your anchor point
2. Set winch dial to L (Low) for maximum pulling power while winching your load
3. Set winch dial to H (High) for retrieving the rope 5x faster with Rapid Rope Recovery

AUTO STOP TECHNOLOGY

AUTO

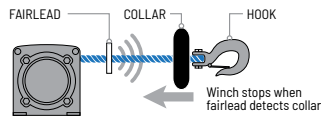

Auto Stop technology protects and extends the life of your winch by automatically stopping the winch at the end of pull to prevent over-spooling. While plowing, it prevents the plow frame from bending by stopping the winch once the plow has been lifted.

PREMIUM SYNTHETIC ROPE

With its lightweight, yet extremely strong, design and superior flexibility, this 50' long synthetic rope is easy to handle and can stand up to any tough job.

WIRELESS REMOTE

This convenient remote operates your Polaris winch wirelessly from within 50' of the vehicle. Operate your winch safely outside your vehicle while on the job site or trails.

MODEL

450 H.O. '21-26
570 '21-26
X2 570 '25-26
TOURING 570 '25-26
6X6 570 '25-26

850 '12-26
XP 1000 '15-26
TOURING XP 1000 '15-26
TOURING 850 '15-26
SCRAMBLER 850 '14-26

XP 1000 S '20-26
SCRAMBLER XP 1000 S '20-26



TOP-OF-THE-LINE FEATURES

BEST FOR PLOWING, HEAVY-DUTY OUTDOOR CHORES & TRAIL RIDING



BUILT FOR THE OFF-ROAD

BEST FOR THE CASUAL OFF-ROAD RIDER

PRO SERIES



NOT AVAILABLE

ADD AUTO STOP TECHNOLOGY



2881693

SYNTHETIC ROPE REQUIRED
FITS WINCHES: 2880434, 2891607



2889253

SYNTHETIC ROPE REQUIRED
FITS WINCHES: 2891608, 2891609,
2891611, 2891612



TOP SELLER
ADD SYNTHETIC ROPE
2878888



ADD WIRELESS WINCH REMOTE
2879316

3,500 LB
WITH SYNTHETIC ROPE

TOP SELLER
2891610

2891613

2891614

3,500 LB
WITH SYNTHETIC ROPE

TOP SELLER
2891609

2891612

2,500 LB
WITH STEEL CABLE

TOP SELLER
2891608

2891611

PLOWS

TAKE COMMAND OF CLEARING SNOW AND MAKE QUICK WORK OF EVEN THE HEAVIEST JOBS



DRIVE UP



HOOK IN



LOCK DOWN

INSTALLATION

30 seconds: drive up, hook on, lock down and go – the integrated Polaris Engineered plow system simplifies plowing.

CONVENIENCE

Lift and angle adjustments can be made from the driver's seat.

ROBUST FRAME

A plow system is only as strong as its frame, and Polaris Engineered plow frames have a wide frame to withstand the rigors of heavy plowing.



DURABLE BLADES

Available in strong stamped steel or corrosion-resistant poly materials, Polaris Engineered plow blades cover a large surface area for quick snow removal.



66" POLY BLADE

60" & 52" STEEL BLADE

PLOW SYSTEMS (WINCH REQUIRED, SOLD SEPARATELY)

Choose a Plow System, designed to help you get the most out of your Sportsman during snowy months. Select a system based on your plowing needs with premium add-ons including a hydraulic lift system or additional plow accessories.

PRO SERIES PLOW SYSTEM WITH HYDRAULICS

System includes:

- Mount (2891253)
- Frame (2879630)
- 66" Poly Plow (2880269)
- Hydraulic Angle (2879635)
- Plow Markers (2872726)
- Plow Deflector (2879866)

» 3880010

450 '15-26, 570 '15-26, 6X6 570 '17-26, X2 570 '15-23, X2 570 '25-26, TOURING 570 '15-26

REQUIRES LIFT METHOD: SEE WINCHES BELOW

PRO SERIES PLOW SYSTEM

System includes:

- Mount (2891253)
- Frame (2879630)
- 60" Steel Plow (2879638)

» 3880011

450 '15-26, 570 '15-26, 6X6 570 '17-26, X2 570 '15-23, X2 570 '25-26, TOURING 570 '15-26

REQUIRES LIFT METHOD: SEE WINCHES BELOW

PRO SERIES PLOW SYSTEM WITH HYDRAULICS

System includes:

- Mount (2881423)
- Frame (2879630)
- 66" Poly Plow (2880269)
- Hydraulic Angle (2879635)
- Plow Markers (2872726)
- Plow Deflector (2879866)

» 3880012

XP 1000 '15-26, 850 '15-26, TOURING 1000 '15-26, TOURING 850 '15-26, SCRAMBLER 850 '15-26

REQUIRES LIFT METHOD: SEE WINCHES BELOW

PRO SERIES PLOW SYSTEM

System includes:

- Mount (2881423)
- Frame (2879630)
- 60" Steel Plow (2879638)

» 3880013

XP 1000 '15-26, 850 '15-26, TOURING 1000 '15-26, TOURING 850 '15-26, SCRAMBLER 850 '15-26

REQUIRES LIFT METHOD: SEE WINCHES BELOW



66", 60" or 52" blades

Choice of poly or steel

Ability to add a hydraulic angle system

MODELS	MANDATORY STEPS			OPTIONAL	
	STEP 1 SELECT A MOUNT	STEP 2 SELECT A FRAME	STEP 3 SELECT PLOW CONFIGURATION	BLADES	STEP 4 ADD HYDRAULICS
XP 1000 '15-26 850 '15-26 850/XP 1000 MUD EDITION '16-26 TOURING XP 1000 '15-26 TOURING 850 '10-26 SCRAMBLER 850 '14-26	TOP SELLER 2881423		3,500 LB Winch 2891613 3,500 LB Winch 2891612 2,500 LB Winch 2891611		
XP 1000 S '20-26 SCRAMBLER XP 1000 S '20-26	2883581		Pro Series 3,500 LB Winch 2891614	66" Poly 2880269	
6X6 570 '17-26 X2 570 '15-26 TOURING 570 '15-26		TOP SELLER 2879630	TOP SELLER Polaris HD 3,500 LB Winch 2880434 TOP SELLER 2,500 LB Winch 2891607	TOP SELLER 60" Steel 2879638	Hydraulic Plow Blade Angle System 2879635
570 '15-26 450 H.O. '16-26 6X6 570 '25-26 X2 570 '25-26 TOURING 570 '25-26	TOP SELLER 2891253		TOP SELLER Pro Series 3,500 LB Winch 2891610 TOP SELLER 3,500 LB Winch 2891609 TOP SELLER 2,500 LB Winch 2891608	TOP SELLER 52" Steel 2879639	
STEP 5 SELECT ACCESSORIES AND REPLACEMENT ITEMS					
66" HD Wear Bar 2879868 66" Wear Bar 2879867 60" Wear Bar 2877243 52" Wear Bar 2877210 60" UHMW Wear Bar 2890651 52" UHMW Wear Bar 2890652	66" Plow Blade Snow Deflector 2879866 60" Plow Blade Deflector 2871808 Skid Shoe 2208864 Shear Pin Replacement 2205063 Coil Spring Spacer 2872655	Plow Winch Rope (for 2,500 LB & 3,500 LB winches) 2878483 Plow Marker (sold in pairs) 2872726 Rear Tire Chains (recommended for rear tires only) 2881422 Plow Blade Track Extension (required for track equipped vehicles) 2879719			

CHOOSE A PLOW SYSTEM

BUILD A PLOW SYSTEM

ACCESSORIES

450 / 570

850 / XP 1000
XP 1000 S

SCRAMBLER 850 /
XP 1000 S

MISCELLANEOUS
& YOUTH

WINCHES, PLOWS
& TRACKS

LIGHTING

CONNECTED
TECHNOLOGY

HUNT & COOLERS

WHEELS & TIRES
& TRAILERING

ALL-TERRAIN TRACTION

It's tough to make Sportsman even more versatile than it already is. But with a set of Prospector Pro Tracks, you'll do just that. Tread through deep snow without concern.



PROSPECTOR PRO 2.0 TRACK SYSTEM

- A** New front dual stabilizer for improved stability
- B** Polaris-specific gearing provides 1:1 ratio to:
 - Minimize track slip, providing better climbing ability and improved traction in deep snow
 - Improve top speed over prior models by approximately 5%
 - Reduce operating RPM for a quieter ride
 - Improve driveline durability, which allows vehicle to run at a lower RPM, decreasing engine wear
- C** Polaris exclusive optimized hub geometry that minimizes feedback and eases steering effort
- D** Lightweight design provides for better flotation, eases steering effort and provides better vehicle control
- E** Flexible lug design provides the highest level of deep snow performance by lifting up in deep snow as opposed to digging down

STEP 1 SELECT A MOUNT KIT		
MODELS	A-ARMS	MOUNT KIT
XP 1000/850 '15-26	STRAIGHT	2879457
XP 1000/850 '16-26 TOURING XP 1000/850 '15-26 MUD EDITION XP 1000/850 '16-26	ARCHED	2882109
XP 1000 S '20-26 SCRAMBLER XP 1000 S '20-26	ARCHED	2883977
570 '21-26 X2 570 '25-26 TOURING 570 '25-26	ARCHED	2889218
450/570 '21-26 X2 570 '25-26 TOURING 570 '25-26	STRAIGHT	2889219
450/570 '14-20 TOURING 570 '15-24 X2 570 '15-21	STRAIGHT	2879497

STEP 2 SELECT A TRACK KIT	
MODELS	TRACK KIT
450/570 '14-26 TOURING 570 '15-23 X2 570 '15-23 X2 570 '25-26 TOURING 570 '25-26	2889493
XP 1000 '15-26 850 '15-26 TOURING XP 1000/850 '17-26 MUD EDITION XP 1000 '16-26 XP 1000 S '20-26 SCRAMBLER XP 1000 S '20-26 SCRAMBLER 850 '13-26	2889495

WANT TO PLOW?

PRO SERIES PLOW TRACK EXTENSION

- Plow extension for use when using the Prospector Pro Track System and plow system

» 2879719

FOR USE WITH PRO SERIES PLOW SYSTEMS



SPORTSMAN SNOW TRACTION OPTIONS

TREAD THROUGH SNOW WITH THESE OPTIONS	CONTACT PATCH	TURNING RADIUS
 <p>STOCK TIRES</p>	<p>GOOD</p> 	<p>139.5"</p> 
 <p>PRO ARMOR WHITEOUT</p>	<p>BETTER</p>  <p>More surface area for better flotation on snow</p>	<p>138.875"</p> 
 <p>PROSPECTOR PRO 2.0 TRACKS</p>	<p>BEST</p>  <p>Less aggressive tread displaces snow for better handling</p>	<p>175.375"</p> 



RIGID

**POLARIS PARTNER
ADVANTAGES**

MOUNTS PERFECTLY
Designed for your Polaris Engineered bumper, roof or other mounting point

**ADVANCED
TECH**

RIGID® lights are driven by Aluminum PCB Smart Boards®, 6063-T5 aircraft aluminum extruded housings and Tiger Drylac® UV protection polyester powdercoating.

**EXCLUSIVE
OPTICS**

RIGID® lights feature impact-resistant polycarbonate lenses for a 100% water/dustproof seal.

**RIGID® LIMITED
LIFETIME WARRANTY**

If you own a RIGID® light and it breaks, we will replace or repair it for life.*



LIGHT BAR TYPES



SR-SERIES PRO

Sleek, powerful, low-profile (under 2" tall). Lights extreme distances with low energy usage.

Available in 10" Flood, Spot & Combo



D-SERIES PRO

Compact to fit almost anywhere with high output and low energy usage.

Available in Driving, Flood & Spot

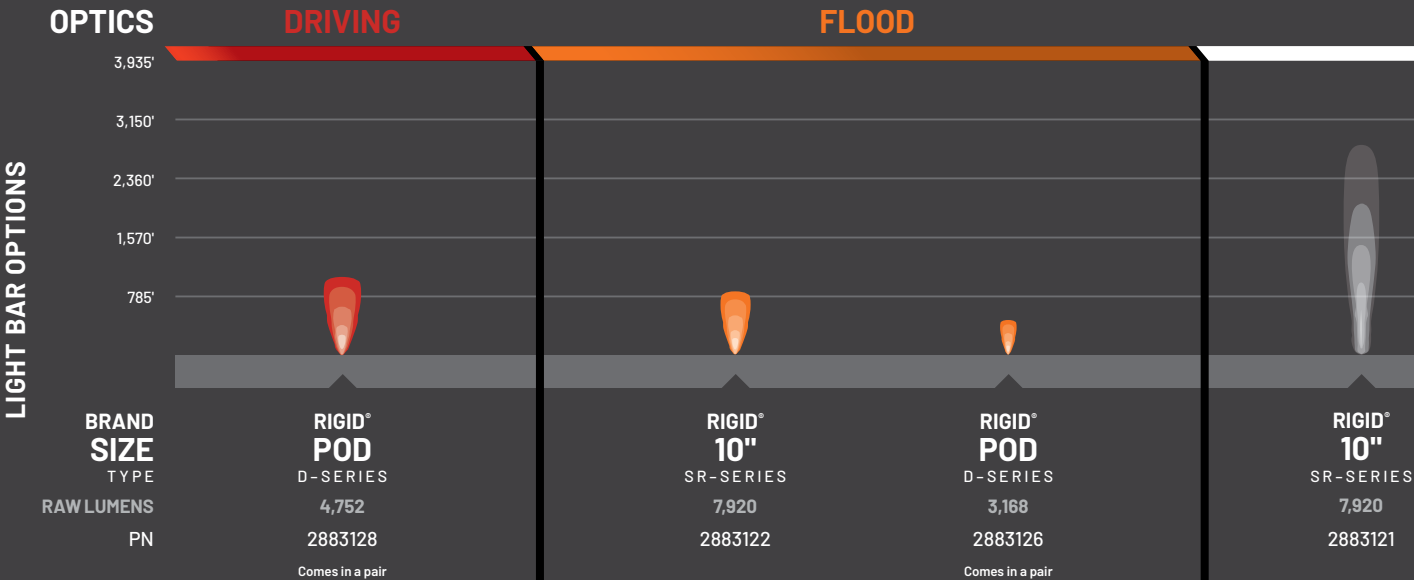

BUILD YOUR VISION

Consider the optics, angle and how you will use your vehicle to choose the right light or set of lights.

OPTICS LIGHT ANGLE	ACCENT	DRIVING (45°)	FLOOD (25°)	SPOT (10°)	COMBO (25°/10°)
DRIVING SPEED	All	Slow to medium	Slow to medium	High	All
BEAM	Diffused glow	Extra-wide	Wide/shorter	Concentrated/long	Inner spot & outer flood
RECOMMENDED MOUNTING	Low/wheel well	All points	Low/rear	High points	All points
TERRAIN & RIDING STYLE	Added style & personalization in any terrain	All riding & utility	Wide-open terrain or trails & utility	Trail & tight conditions	All riding & utility

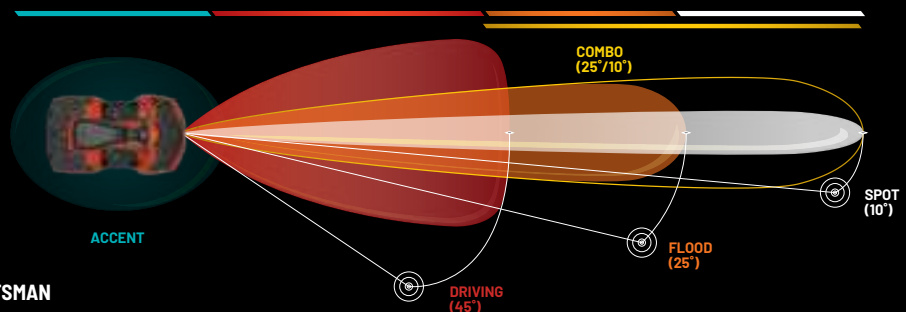

MAX PERFORMANCE

Validated to work as hard as your machine does

DOESN'T OVERTAX

Trust it to work when you need it to

PRO ARMOR®



RUGGED CONSTRUCTION

Pro Armor lights are designed to be big and beefy with an aggressive style all their own, and housed in IP67 marine-grade rated UV polyester powdercoating.

MASSIVELY BRIGHT

Pro Armor builds bright lights designed for any riding experience. All that power is directed through heat dissipating aluminum for streamlined heat management.



SINGLE-ROW LED

Powerful, compact, low-profile light bars with sleek look.

Available in 20" Combo



CUBE LED

Small size allows mounting in strategic locations for added lighting.

Available in Spot

SPOT

COMBO

OPTICS



1,200 m
960 m
720 m
480 m
240 m

RIGID® POD

D-SERIES
3,168

2883127

Comes in a pair

PRO ARMOR CUBE

DUAL-ROW
1,500

2889794

2889795

RIGID® 10"

SR-SERIES
7,920

2883123

PRO ARMOR 20"

SINGLE-ROW
4,700

2889792

BRAND SIZE

TYPE
RAW LUMENS
PN

POLARIS ENGINEERED

LED LIGHT KIT

- Upgrade your standard headlights and pod lights to LEDs with this upgrade kit

» 2884859

SPORTSMAN XP 1000 S '21-26,
SPORTSMAN 850/1000 '21-26,
SPORTSMAN 450/570 '21-26

DOES NOT WORK WITH MODELS PRIOR TO '21



LED LIGHT BAR WIRING HARNESS

- Control one light with one switch

» 2882320

ALL SPORTSMAN MODELS

LED Y-HARNESS

- Requires 2882320 to control two cubes or two lights with one switch

» 2879860

ALL SPORTSMAN MODELS

* If RIGID® determines, in its sole discretion, that your product is defective in material or workmanship, RIGID® will honor your warranty claim. In some cases the product will be replaced, depending on the specific time frame of the purchase. If the product is repaired, all parts, labor and return shipping may be covered by RIGID®.

SHOP & VERIFY VEHICLE FITMENT AT
[POLARIS.COM/ShopSPORTSMAN](https://www.polaris.com/ShopSPORTSMAN)

ACCESSORIES

450 / 570

850 / XP1000
XP1000 S

SCRAMBLER 850 /
XP1000 S

MISCELLANEOUS
& YOUTH

WINCHES, FLOWS
& TRACKS

LIGHTING

CONNECTED
TECHNOLOGY

HUNT & COOLERS

WHEELS & TIRES
& TRAILERING

CONNECTED TECHNOLOGY

GO REMOTE.
STAY CONNECTED.



POLARIS RIDECOMMAND

PLAN YOUR RIDE

Plan an epic ride with stops along the way and ensure you're on a marked trail with Snap-to-Trail technology. Later, share your route with friends so you can hit the trails together.

FOLLOW THE GROUP

With patented Group Ride technology, you can ride at your own speed and keep fellow riders in sight on your map screen, even if you get split up. Because rides are meant to be shared.

WORK SMARTER

Plow Mode automatically raises and lowers the plow depending on the gear you're in so that you can get your work done quicker.

DISCOVER NEW TRAILS

With over 1,300,000 miles of trails available offline, you'll have the confidence to explore further, whether you have cellular coverage or not.

AVAILABLE ON RIDE COMMAND EDITION/ULTIMATE MODELS & AS AN ACCESSORY
7" DISPLAY POWERED BY RIDE COMMAND

Industry-leading 7" display with glove-touch compatibility and visible in all conditions.

Configurable Gauges

Customize your ride experience with elevation, travel direction, fuel level and more to create relevant screens for you.

Personalized Audio Experience

Seamlessly pair to your display via Bluetooth® to wirelessly stream music and stay connected with call and text alerts. Add the Lock & Ride Rear Audio Storage Box to stream music. (Requires Lock & Ride Rear Audio Storage Box and Rear Power Harness.)

Industry-Exclusive Plow Mode

Quick and easy plowing. Plow automatically lowers when shifted into low gear and raises when shifted into reverse. (Requires Polaris Winch with Auto Stop Technology and Synthetic Rope. Learn more on P. 54)

7" Display Mount Kit Included

Comes with required wiring harnesses and accessory components. Includes V2V and GPS antenna.

» 2889455

SPORTSMAN 450/570 '22-26, SPORTSMAN 850/1000 '22-26, TOURING 570 '25-26

LEARN MORE AND DOWNLOAD AT
RIDECOMMAND.POLARIS.COM



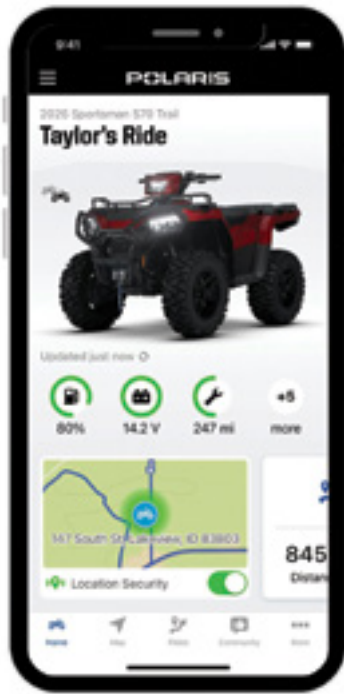

	POLARIS RIDECOMMAND	POLARIS RIDECOMMAND+
VEHICLE OWNERSHIP	GARAGE	✓
	WARRANTY STATUS	✓
	MAINTENANCE REMINDERS	✓
	ISSUE DIAGNOSTICS	✓
	VEHICLE HEALTH	✓
RIDING FEATURES	COMMUNITY	✓
	CONTENT SHARING	✓
	RIDE PLANNING	✓
	WAYPOINTS	✓
	RIDE TRACKING	✓
	RIDE TRACKING+	✓
	GROUP RIDE	✓
SECURITY	VEHICLE LOCATOR	✓
	LOCATION ALERTS	✓
	CHECK-IN MESSAGES	✓

ACCESSORIES

450 / 570

850 / XP1000
XP1000 S

SCRAMBLER 850 /
XP1000 S

MISCELLANEOUS
& YOUTH

WINCHES, FLOWS
& TRACKS

LIGHTING

CONNECTED
TECHNOLOGY

HUNT & COOLERS

WHEELS & TIRES
& TRAILERING

POLARIS RIDECOMMAND+

THE LATEST IN INDUSTRY-LEADING CONNECTED VEHICLE TECHNOLOGY

Stay connected to your Sportsman from anywhere with vehicle telematics shared directly to the palm of your hand.



LOCATION ALERTS



VEHICLE HEALTH



RIDE TRACKING+ & GROUP RIDE+



ISSUE DIAGNOSTICS



MAINTENANCE REMINDERS

AVAILABLE ON SELECT 2023 & NEWER MODELS

RIDE COMMAND+ CONNECTED VEHICLE ACCESSORIES*

» 3880083

SPORTSMAN 850 '23-26, SPORTSMAN 1000 '23-26, SPORTSMAN XP 1000 '23-26
INCLUDES ALL TRIMS & RIDE COMMAND EDITIONS
DOES NOT FIT MUD EDITION

» 3880081

SPORTSMAN 570 '23-26

» 3880082

SPORTSMAN 450 '23-26

*Kits includes all necessary accessories to activate RIDE COMMAND+

VOYAGER PRO



VOYAGER PRO KIT, ATV

Bright, 4" touchscreen visible in all conditions.

Compatible with RIDE COMMAND.

Pre-Loaded Base Maps

The map screen is enabled with base maps, topography lines, hill shading and select trails. Record or load GPS trails/riding areas and transfer to a PC.

» MODEL-SPECIFIC KITS

Buddy Tracking

Track up to 20 group members no matter what type of vehicle they are riding.

Bluetooth® Enabled

Bluetooth® enabled for intercom, phone and media controls. Play songs from your phone or MicroSD card using a Bluetooth® headset, speaker or intercom. Two phones and two headsets can be connected at the same time.

4" RIDE COMMAND COMPANION DEVICE

AVAILABLE ON POLARIS.COM AND AT YOUR LOCAL DEALER



HUNT

KOLPIN[®] OUTDOORS

PROTECTING YOUR ESSENTIAL GEAR SINCE 1943



KOLPIN STRONGHOLD SYSTEM

Polaris is proud to partner with Kolpin Outdoors, an industry leader in off-road accessories and the premier name in gun boots and mounts. If you need to secure a firearm while riding, simply attach the auto-latch mount and choose your gun boot.

IDEAL FOR SECURE TRANSPORT OF SCOPED RIFLES AND SHOTGUNS.

STEP 1 CHOOSE YOUR MOUNT

STEP 2 CHOOSE YOUR BOOT



KOLPIN STRONGHOLD AUTO-LATCH MOUNT

- The auto-latch provides quick and secure attachment of Kolpin Stronghold Gun Boots
- Bracket is made from rugged high impact, reinforced nylon and coated steel with precision angle adjustment for a custom fit
- For use with Kolpin Stronghold Gun Boots (sold separately)

» 2882272

SPORTSMAN 850/1000 '17-26
DOES NOT FIT WITH ULTIMATE SERIES BODY ARMOR (2882090)



KOLPIN STRONGHOLD AUTO-LATCH MOUNT

- The Auto-Latch provides quick and secure attachment of Kolpin Stronghold Gun Boots
- Bracket is made from rugged high impact, reinforced nylon and coated steel with precision angle adjustment for a custom fit
- For use with Kolpin Stronghold Gun Boots (sold separately)

» 2884846

TOURING 570 '25-26, SPORTSMAN TOURING 570 '25-26,
SPORTSMAN 450/570 '21-26



KOLPIN STRONGHOLD GUN BOOT L

- 52" L x 4 3/4" W x 9 1/4" H
- Requires Auto-Latch Mount 2882272 or 2884846 to mount to vehicle

» 2882426

SPORTSMAN 850/1000 '17-26, TOURING 570 '25-26,
SPORTSMAN 450/570 '14-26



KOLPIN RHINO GRIPS

IDEAL FOR CARRYING RIFLES, SHOTGUNS, BOWS AND CROSSBOWS.

LR RHINO GRIP PRO - ATV

- » 2884119
- » REPLACEMENT RUBBER STRAPS • 2884109
ALL SPORTSMAN MODELS (EXCEPT UTILITY EDITIONS & YOUTH)



LR RATCHETING RHINO GRIP - ATV

- » 2881157
ALL SPORTSMAN MODELS (EXCEPT UTILITY EDITIONS & YOUTH)



LR RHINO GRIP XLR - ATV

- » 2889147
- » REPLACEMENT RUBBER STRAPS (2) • 2889204
ALL SPORTSMAN MODELS (EXCEPT UTILITY EDITIONS & YOUTH)



LR RHINO GRIP XLR - DOUBLES - ATV

- » 2889148
- » REPLACEMENT RUBBER STRAPS (2) • 2889204
ALL SPORTSMAN MODELS (EXCEPT UTILITY EDITIONS & YOUTH)



All Kolpin Rhino Grips are Lock & Ride compatible and come with required mounting hardware.

ADDITIONAL STORAGE OPTIONS

KOLPIN STRONGHOLD GUN BOOT XL

- Lockable and TSA Approved
- Includes padded, zippered internal protective liner
- 52" L x 3 3/4" W x 10 1/2" H
- Requires Auto-Latch Mount 2882272 or 2884846 to mount to vehicle

» 2882036

XP 1000 '17-26, 850 '17-26, TOURING 570 '25-26, 570 '19-26, 450 H.O. '21-26

KOLPIN GUN BOOT IV

- For 50mm scopes, rifles with slings attached, or shotguns up to 51" in length

» BLACK • 2872677

REQUIRES MOUNT 2878001 TO MOUNT TO SPECIFIC SPORTSMAN MODELS



LR GUN BOOT MOUNTS

- Works with Lock & Ride XL Storage Box, Lock & Ride Rear Cargo Box and Rear Rack Extenders

» 2878001

SPORTSMAN 850/1000 TOURING '10-26

ONLY COMPATIBLE WITH KOLPIN GUN BOOT IV - NOT COMPATIBLE WITH KOLPIN STRONGHOLD GUN BOOTS



COOLERS

MADE FOR RIDERS.
BUILT FOR LIFE.



30, 60 & 105
QUART FEATURES



ComfortCarry
Handles



TravelLock
System



EasyOut
Drain System



NoSlip
Rubber Feet



PolarWall
Insulation



IceLock
Seal



105 QUART

SAGEBRUSH GREEN • 2890707
GRAPHITE • 2883426

ACCESSORIES
WIRE BASKET • 2883648
DIVIDER (1) • 2883468
WHEELS • 2883967

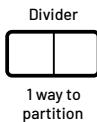

60 QUART

SAGEBRUSH GREEN • 2890706
GRAPHITE • 2883425

ACCESSORIES
WIRE BASKET • 2882185
DIVIDERS (2) • 2882184
SEAT CUSHION • 2882179
WHEELS • 2882180



30 QUART

SAGEBRUSH GREEN • 2890705
GRAPHITE • 2883424

ACCESSORIES
WIRE BASKET • 2882438
DIVIDER (1) • 2882186



ESSENTIAL ACCESSORIES SO YOUR COOLER WORKS AS HARD AS YOU DO

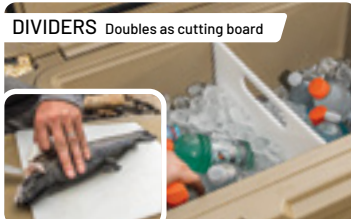



POLARIS NORTHSTAR COOLERS CAN SURVIVE JUST ABOUT ANYTHING - FROM EXTREME HEAT TO A NASTY TUMBLE OFF A VEHICLE.



15 QUART

SAGEBRUSH GREEN • 2890704
GRAPHITE • 2883968



**20 QUART
SOFT-SIDED COOLER**

GRAPHITE • 2889285



**HOLDS ICE
FOR AGES**

**BECAUSE JUST ANY COOLER
WON'T CUT IT OUT THERE.**

You need something rugged and reliable. A cooler purpose-built to handle the challenges of the off-road—while keeping your provisions on ice for days on end. Because out here, there are no ice machines, and you just left the last one in your dust. So, load it up. Lock it in. And know your NorthStar cooler is staying put—giving you a few extra days of ice time to enjoy the wild.



TUMBLER



20 OZ • 2883393

WHEELS & TIRES



PRO ARMOR

**OFF-ROAD, IT'S ALL ABOUT
FREEDOM & CREATING
YOUR OWN PATH**

As serious riders ourselves, we get it. And everything we design is to get (and keep) you going on the ride of a lifetime. We're for every style of rider looking to go beyond the expected with a ride that will make your story epic.





WHY CHOOSE PRO ARMOR?

SUPERIOR PERFORMANCE & DURABILITY

LIFELONG PERFORMANCE

- Every tire is designed and constructed with **longevity** in mind
- **3,000+ mile rated** (4,828 kilometers)

PREMIUM PROTECTION

- Pro Armor makes tires with **extra protection** exactly where it's needed most – the sidewall
- **Triple-belted sidewalls** keep your tires more resistant so you can keep going
Many competitors only use double-belted sidewalls

TOUGH TIRES

- Higher ply ratings mean added protection
- Pro Armor builds 8 or 10-ply rated tires for **higher puncture-resistance**



TIRES

Developed and tested with Polaris engineers, ensuring the perfect fit and optimal performance mile after mile.



12"
14"
WHEEL

PRO ARMOR PRESERVE

Turf-friendly for areas requiring low-impact from treads.

Why Choose Preserve?

Perfect for locations where you don't want to risk damaging turf.



12"
WHEEL

PRO ARMOR XD-K

These heavy duty tires are one of the strongest we've ever built. Superior puncture resistance, ride quality and long life.

Why Choose XD-K?

Triple-belted sidewall resists puncture.



12"
14"
WHEEL

PRO ARMOR HARVESTER

Designed for trail & agricultural applications with excellent grip, minimal crop impact and long wear life.

Why Choose Harvester?

Great for unexpected impact and rugged terrain.



14"
WHEEL

PRO ARMOR X TERRAIN

Handle anything the trail throws your way, with a durability-driven design that provides a comfortable and confident ride.

Why Choose X Terrain?

Triple-belted sidewall resists puncture.



12"
14"
WHEEL

PRO ARMOR TREKKER

The best balance of on-trail handling and low tire noise.

Why Choose Trekker?

Ultimate predictability with a quiet ride.



14"
WHEEL

DUAL-DUROMETER

PRO ARMOR DUAL-THREAT

Dual compound technology for superior grip and traction.

Why Choose Dual-Threat?

Softer outer lugs for cornering grip and feel; harder inner lugs for longer tread life.



14"
WHEEL

PRO ARMOR ATTACK

Aggressive tread design provides traction in any environment.

Why Choose Attack?

Great all-season tire with wider lug spacing for grip in softer terrain.



14"
WHEEL

PRO ARMOR WHITEOUT

Engineered to charge through snow with unprecedented flotation and traction.

Why Choose Whiteout?

More surface area for better flotation on snow.

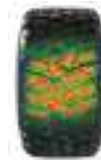

14"
WHEEL

DUAL-COMPOUND

PRO ARMOR MUD XC

The best tread design that balances aggressive traction in the mud with a smoother ride on the trail.

Why Choose Mud XC?

Perfect mud-trail crossover.



SCAN FOR
MORE DETAILS

Pro Armor tires have been developed and tested to ensure the perfect fit, superior durability and optimal performance, mile-after-mile. No matter where you ride - mud, dirt, sand or snow - we've got you covered.



KNOW YOUR TERRAIN



- Tread patterns optimized for extreme traction
- Ideal for both hard pack & loose trail



- Provides traction & durability
- Performs in hard sand, jagged rocks or any extreme terrain



- Flexible "grippy" tread
- Aggressive side bite



- Extra deep treads
- Self-cleaning lugs



- Triple-belted sidewalls to resist puncture
- Purpose-built, long lasting tread patterns



- Handles extreme cold
- Holds shape & provides traction

WHEELS



40-SERIES

BEADLOCK INCLUDED

INNER AND OUTER
BEADLOCK INCLUDED

A 4101 ○

WEIGHT: 14.5 LBS	LOAD RATING: 800 LBS	OFFSET: -35
MATTE BLACK	FRONT/REAR	14" x 10" 1522958

C 4204 ○

FRONT	WEIGHT: 13 LBS	LOAD RATING: 900 LBS	OFFSET: +4
REAR	WEIGHT: 14 LBS	LOAD RATING: 1300 LBS	OFFSET: -9
ACCENT	FRONT	14" x 7"	1522546-266
	REAR	14" x 8"	1522547-266
MATTE BLACK	FRONT	14" x 7"	1522546-458
	REAR	14" x 8"	1522547-458

E 4301 BEADLOCK

WEIGHT: 16 LBS	LOAD RATING: 1600 LBS	OFFSET: +38
ACCENT	FRONT/REAR	14" x 7" 1523284
MATTE BLACK	FRONT/REAR	14" x 7" 1523283

B 4202 ○

FRONT	WEIGHT: 12.75 LBS	LOAD RATING: 900 LBS	OFFSET: +4
REAR	WEIGHT: 13.5 LBS	LOAD RATING: 1300 LBS	OFFSET: -9
ACCENT	FRONT	14" x 7"	1522544-266
	REAR	14" x 8"	1522545-266
MATTE BLACK	FRONT	14" x 7"	1522544-458
	REAR	14" x 8"	1522545-458

D 4205 ○

FRONT	WEIGHT: 10.5 LBS	LOAD RATING: 900 LBS	OFFSET: +4
REAR	WEIGHT: 12.5 LBS	LOAD RATING: 1300 LBS	OFFSET: -9
MATTE BLACK	FRONT	14" x 7"	1521507-521
	REAR	14" x 8"	1521508-521
LUSTER	FRONT	14" x 7"	1521507-410
	REAR	14" x 8"	1521508-410

F HD DUAL BEADLOCK ○

WEIGHT: 40 LBS	LOAD RATING: 1,600 LBS	OFFSET: +38
MATTE BLACK	FRONT/REAR	14" x 7" 1524022-458

KNOW YOUR WHEELS

STEP 1: SELECT YOUR SERIES

4 = 40-SERIES

STEP 2: CHOOSE YOUR LOAD RATING

1 = <800 LBS

2 = 801 - 1,300 LBS

3 = 1,301 - 1,600+ LBS

STEP 3: PICK YOUR STYLE

OFFSET / BEADLOCK / COLOR

INCREASE OFFSET FROM STOCK =
NARROWER STANCE

DECREASE OFFSET FROM STOCK =
WIDER STANCE

14" FORGED BEADLOCK RINGS

MACHINED 1522244-266

ONLY USED ON 4203 BEADLOCK
& HD DUAL BEADLOCK
SOLD INDIVIDUALLY



MATTE BLACK 1523146-458

ONLY USED ON 4301 BEADLOCK
& HD DUAL BEADLOCK
SOLD INDIVIDUALLY



2 WAYS TO PURCHASE

INDIVIDUAL WHEELS & TIRES
- OR -
COMPLETE SETS AS LISTED



SCAN TO BUILD
YOUR CUSTOM SET
& VERIFY FITMENT

Exclusively at Polaris Authorized Dealers
or Polaris.com/ProArmorSPORTSMAN



WHEEL & TIRE SETS



40-SERIES

	TRAIL				MUD	UTILITY		SNOW
	TREKKER 27"	X TERRAIN 27"	ATTACK 26"	DUAL-THREAT 26"	MUD XC 27"	PRESERVE 27"	HARVESTER 27"	WHITEOUT 27"
4101 ○ MATTE BLACK								2882382
4202 ○ ACCENT	2890907	2889968	2881335	2883140	2884267		2882383	
4202 ○ MATTE BLACK	2890905	2889969	2881336	2883141	2884268	2883204	2882384	
4204 ○ ACCENT		2889973	2881347	2883142	2884270	2883205	2882385	
4204 ○ MATTE BLACK		2889974	2881348	2883143	2884271		2882386	
4205 ○ LUSTER			2881359	2883144				
4205 ○ MATTE BLACK		2889975	2881360	2883145	2884269	2883207	2882387	
4301 BEADLOCK ACCENT BEADLOCKS PRE-MOUNTED		2889970		2883217				
4301 BEADLOCK MATTE BLACK BEADLOCKS PRE-MOUNTED		2889971		2883216				

LUG NUTS

○ Lug Nuts Required



METRIC LUG NUTS FOR ALUMINUM RIMS

- » SET OF 4 • 2877385
 - » SET OF 16 • 2877384
- SPORTSMAN XP

SAE LUG NUTS FOR ALUMINUM RIMS

- » SET OF 4 • 2876754
 - » SET OF 16 • 2877409
- SPORTSMAN 450/570

COLBY VALVE SHORT ULTIMATE VALVE - 2 PACK

» 2883292



COLBY VALVE EMERGENCY VALVE - 2 PACK

» 2883293



COLBY COMBO VALVE KIT - 16 PACK

- Includes eight Ultimate Valves and eight Emergency Valves
- » 2883294

ORDERABLE THROUGH LOCAL DEALER ONLY



TIRE SEALANT

P. 74

- » 32 OZ. • 2830484
- » 1 GALLON • 2830485
- » 5 GALLONS • 2830486
- » 5 GALLONS PUMP • 2830487

TIRE SEALANT

24 X 7 COVERAGE | BE PREPARED FOR ANYTHING

HOW IT WORKS

- 1 Tire sealant remains liquefied inside the tire until a leak develops in the tire or wheel.
- 2 Once a leak occurs, the tire sealant rushes out of the tire and quickly creates a permanent solid plug, maintaining tire pressure so you can continue your ride.



HOW MUCH DO YOU NEED?

$$\text{TIRE HEIGHT (IN.)} \times \text{TIRE WIDTH (IN.)} / 5 = \text{OUNCES REQUIRED PER TIRE}$$

VISIT POLARIS.COM/TIRESEALANTCHART TO LEARN MORE

PREMIUM TIRE SEALANT

- Instantly seals and repairs rim, bead leaks and punctures up to .25" on standard tires and .75" on heavy ply tires
- Helps seal the tire bead against the wheel
- Creates permanent repair, helps maintain air pressure for the life of the tire
- 100% water soluble for easy cleanup
- Remains fluid and effective in temperatures down to -45° F
- Will not rust, corrode or pit wheels
- Easily installed through existing tire valve stem with valve core removed

- » 32 OZ • 2830484
- » 1 GALLON • 2830485

- » 5 GALLONS • 2830486
- » 5 GALLONS PUMP • 2830487

- » 55 GALLONS • 2830489
- » 275 GALLONS • 2830488

TRAILERING

RAMPS



CALIBER® RAMP PRO

- Designed for ATVs and UTVs up to 50" wide
- Integrated grip glides for ultimate traction
- Folding sides for easy transportation and storing
- » 52" x 90" • 2884576



ALUMINUM ARCHED LOADING RAMPS

- Capacity for up to 3,000 LBS
- » 76" x 12" • 2,000 LB • 2875384
- » 88" x 12" • 3,000 LB • 2875386



LIGHTWEIGHT TRI-FOLD RAMPS

- Ramp folds up for transport
- Capacity for up to 1,500 LBS
- Safety straps included
- » 72" x 51" • 2875385
- » 82" x 51" • 2875860



FOLDING ALUMINUM ARCHED RAMPS

- Ramp folds up for transport
- Up to 1,500 LBS total capacity, 750 LBS per individual ramp
- Safety straps included
- » 88" x 12" • 2875387

COVERS & MISC



TRAILERABLE COVER

- » 2876614
SPORTSMAN 450/570,
SPORTSMAN 850/1000
REPLACEMENT STRAP 2871912
- » 2877999 (SHOWN)
ALL SPORTSMAN TOURING
REPLACEMENT STRAP 2871912



OFF-ROAD TOOL KIT BY CRUZTOOLS®

- » 2890429
ALL MODELS

CV BOOT REPAIR KIT*

FIX ON THE GO | TEMPORARY COVERAGE

- A quick trail-side fix to increase trail time
- The flexible and durable boot material expands over a cone tool for CV boot repairs, without disassembling CV axles
- Universal fit – works as a temporary fix for most powersports axles
- All components fit inside the cone, and a cover is provided for compact durable storage
- Easily fits in a cargo box, attached to the roll cage, in the glovebox or many other storage locations



Items shown are contained inside cone

ATV CV BOOT REPAIR KIT

Kit includes the following items:

- (1) Expandable CV Boot
 - (1) Reusable Cone Tool
 - (2) CV Boot Clamps
 - (1) Tube of Silicone Lube
 - (1) Grease Packet
 - (1) Cone Cover
- » 2830528

ATV TRAIL BOOT ONLY

» 2830529

UTV

- » CV REPAIR KIT 2830526
- » TRAIL BOOT ONLY 2830527

SEE HOW THE CV BOOT REPAIR KIT WORKS AT POLARIS.COM/MAINTENANCE-VIDEOS



HOW TO INSTALL

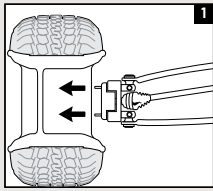

Remove wheel and axle nut.

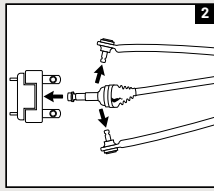

Remove brake caliper, hub, tie rod and upper and lower ball joints.

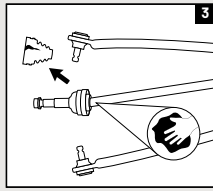

Remove old boot and clean joint.

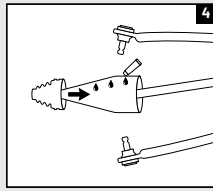

Spread silicone lube on entire cone tool. Slide boot over cone tool, large end first. See package for outer boot instructions.

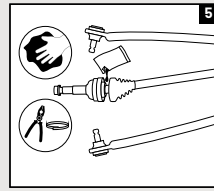

Empty the bag of grease into the CV joint/boot, clean sealing points and install clamps.

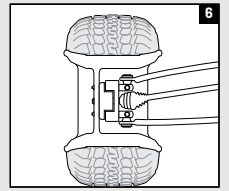

Reassemble tie rod, ball joints, brake caliper, axle nut, tire and wheel.

Refer to your service manual for further instructions and torque specifications.
*Designed for temporary CV boot repair. Purchase the OEM CV Boot for a permanent repair.

HITCHES



HITCH WITH 2" BALL

- 3:1 Hitch: ball, hook and pin design
 - Rust resistant steel with powdercoat finish
 - Removable ball, 5/8" pin and clip
- » 2" x 2" RECEIVER • 2830522
» 1 1/4" x 1 1/4" RECEIVER • 2830523



1 7/8" BALL

- 1 7/8" replacement ball for hitch
 - Designed to work with 3:1 Hitch
- » 2830524



RECEIVER HITCH

- » 2" RECEIVER TONGUE 2875320



TRAILER BALL 3/4" SHANK

- » 1 7/8" BALL • 2877602
- » 2" BALL • 2877603

STRAPS & ROPES



RECOVERY STRAP

- 2" x 30'
 - 18,000 LB maximum load, 9,000 LB maximum vehicle weight
 - Comes with carry bag
- » 2884033



RATCHET STRAP

- 1.5" x 15' straps, 2 pack
 - Heavy duty webbing
 - 5,500 LB maximum load, 1,833 LB working load
- » 2884031



RATCHET STRAP

- 2" x 20'
 - Heavy duty webbing, floating D-rings, double J-hooks
 - 10,000 LB maximum load, 3,300 LB working load
- » 2884032



SHOCK STRAPS

- 1.5" 3,000 LB breaking strength
 - Keeps tension on tie-down straps to secure load, 2 pack
- » 1.5" x 15' • 2883296
» 1.5" x 7' • 2883295



MAINTENANCE & GARAGE

FACTORY APPROVED. Every Polaris vehicle has been engineered and manufactured to deliver performance. Keep it that way by using the same lubricants, cleaners and service parts our factory-trained technicians use.



MAINTENANCE & GARAGE

OIL & LUBRICANTS

GARAGE ACCESSORIES

BATTERY CHARGERS & SERVICE PARTS

HEAVY DUTY PARTS



OIL & LUBRICANTS

Our PS-4 engine oils provide ultimate performance and protection, they're formulated with exclusive additives to keep engines clean from deposit buildup. These powersports-grade full synthetic oils helps maximize power and protect your engine for the long term.



PS-4 FORMULATIONS BEST PROTECTION, BEST PERFORMANCE

PS-4 5W-50 FULL-SYNTHETIC OIL

Optimal for ambient operating temperatures of -40° F to 100° F.

1 Quart 2876244 1 Gallon 2876245 16 Gallons 2876247 55 Gallon Drum 2876246 330 Gallon Tote 2878814

PS-4 0W-50 EXTREME FULL-SYNTHETIC OIL

Optimal for ambient operating temperatures of -45° F to 130° F.

1 Quart 2889395 1 Gallon 2889396 16 Gallons 2889397 55 Gallon Drum 2889398 330 Gallon Tote 2889399

OIL CHANGE KITS

These convenient kits include everything needed including filter and oil volume per vehicle

PART NUMBER	VEHICLE FITMENT	PART NUMBER
2890882	RANGER XD 1500	2890883
2202166	RANGER 500, RANGER/RZR/SPORTSMAN 570, TWIN 600, TWIN 700, TWIN 800	2890056
2879323	RANGER, GENERAL 900-1000, RZR 900-1000, RS1, POLARIS XPEDITION	2890057
2877473	RANGER/SPORTSMAN 300-500, SPORTSMAN/SCRAMBLER 500/850/1000	2890055
2881696	RZR TURBO (NON PRO R)	2890058
2890880	RZR PRO R	2890881

POLARIS INVESTS IN EACH OIL AT & ABOVE THESE LEVELS

**12+ DEDICATED
TEAM MEMBERS**
FOCUSED ON POLARIS OIL

**18+
MONTHS**
DEVELOPMENT & TESTING

**76,000+
HOURS**
DYNO TESTING

**2.2/3.5 MILLION+
MILES/KM**
FIELD TESTING



DOT 4 BRAKE FLUID

A high-quality brake fluid designed for use in Polaris hydraulic brakes.
» 12 OZ • 2872189



SUSPENSION/ U-JOINT GREASE

» 3 OZ • 2871515
» 14 OZ • 2871551



GAS SHOCK OIL

» 1 QT RACING • 2874124
WALKER EVANS RACING
REBUILDABLE SHOCKS
» 1 QT PREMIUM • 2870995
FOX® REBUILDABLE SHOCKS



AGL

Protects transmission components against wear, corrosion, oxidation and foam in transmissions.
» 1 QT • 2878068
» 1 GALLON • 2878069
» EXTREME • 1 QT • 2891028



POLARIS
EXTREME
SYNTHETICS

PS-4 EXTREME SYNTHETIC 0W-50

- Our best extreme high and low temp formula, excellent for high temperatures and racing, even at temps of 130°F, plus easier cold starting even below -45°F
- Expect the best in wear protection thanks to premium PAO and ester base stocks combined with a balance of moly and ZDDP additives
- Polaris exclusive clean engine additive system reduces deposits and carbon build-up for peak performance and power

THE BEST PROTECTION, MAXIMUM PERFORMANCE

- Powersports grade full synthetics provide long lasting engine protection
- At least 40% improved wear protection compared to all aftermarket oils tested (see engine wear test chart)
- Polaris exclusive clean additive system
- At least 50% less deposits than all aftermarket oils tested (see deposit test chart)
- Cleaner engine with less deposits means consistent maximum power and performance

WIDEST VISCOSITY FOR ULTIMATE PROTECTION



ENGINE WEAR TEST

LOWER NUMBER = LESS ENGINE COMPONENT WEAR
LESS WEAR ON PARTS MEANS LONGER ENGINE LIFE

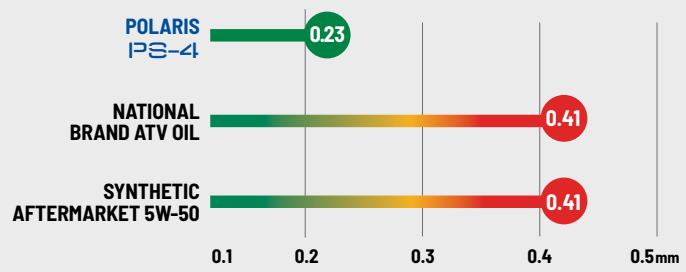

ASTM D4172. In 3rd party testing against 9 competitive products Polaris had 40% or better wear protection compared to all of the tested products. Numbers represent mm of wear scarring measured. Test measures wear at contact points, wear scar is measured for its length and width (in units of mm). Lower wear numbers mean better wear protection and friction reduction.

DEPOSIT TEST

LOWER DEPOSITS = MAXIMUM POWER

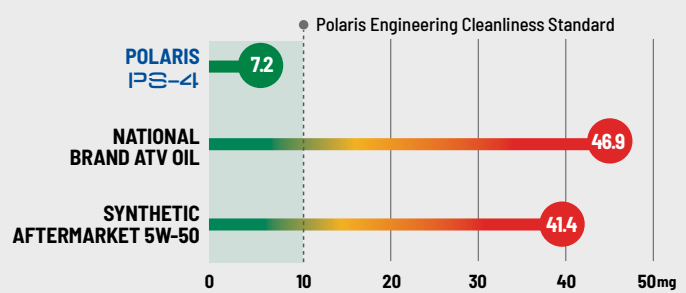

ASTM D6335. In 3rd party testing against 9 competitive products Polaris PS-4 had less than half the deposits compared to the next closest product. No other tested products met Polaris Engineering standards for deposit cleanliness. Test measures mass of deposits in mg in high temp, high stress test cycles. Higher deposits will impact engine power and performance.



DEMAND DRIVE FLUID

Proprietary formulation prevents clutch slippage and chatter and reduces component wear and corrosion.

- » 1 QT • 2877922
- » 2.5 GALLONS • 2877923



ANTI-FREEZE

Prevent corrosion on metal components, eliminate scaling and maximize cooling system performance.

- » 1 QT • 2880514
- » 1 GALLON • 2880513
- » 55 GALLONS • 2880512



CARBON CLEAN

Ultimate fuel and injection system cleaner.

- » 12 OZ • 2881413



ADVANCED FUEL TREATMENT

Dual antioxidant formula protects jets and fuel system from gum and varnish.

- » 12 OZ • 2881416

GARAGE ACCESSORIES



BELT CHANGE TOOL KIT

- Be prepared for whatever the outdoors throws your way
 - Includes everything you need to get back on the move
 - Rolls up to fit easily under seats, in glove boxes or storage bins
 - Does not include Belt
- » 2830611



ESSENTIAL KIT

- Contains Jumper Cables, Portable Trail Tech Air Compressor, Ratchet Strap, Tow Strap, Tire Plug Kit, First Aid, Duct Tape, Electrical Tape, Zip Ties, Rag, and Case
- » 2881207



PARTS TRAY CABINET

- Roller bearing design
- 20.5" W x 16.75" D x 14.75" H
- » PARTS TRAY CABINET W/ 4 DRAWERS • 2830605
- » SQUARE DIVIDERS (24 COMPARTMENTS) • 2830606
- » ADJUSTABLE DIVIDER • 2830607
- » CABINET STAND • 2830608
- » CABINET WITHOUT DRAWERS • 2830609



FLEXIBLE CLUTCH COVER TOOL

- Set includes:
 - (1) 1/4" drive x 11" flexible driver
 - (1) 1/4" Drive double sided socket - 1/4" x 8mm
 - Rubber grip handle and flexible shaft for better leverage
- » 2830572



BATTERY OPERATED FLUID TRANSFER PUMP

- Liquid transfer pumps 5-6 QTS/min suctioning power
 - Powered by two 'D' batteries (not included)
- » 2830513



BATTERY OPERATED FLUID TRANSFER PUMP WITH FLOW CONTROL NOZZLE

- Ideal for quick transfer of fluid, diesel, DEF/Adblue, water & water-based media
 - Handheld flow control nozzle
 - Powered by two 'D' batteries (not included)
- » 2830595



FLUID FUNNEL

- Narrow spout for controlled pouring
 - Designed to prevent overfills
 - Durable for all types of chemical exposure
- » 2830552



FLUID SYRINGE

- Easily add and remove fluid from your vehicle
- » 2830553



FLUID CHANGE TRAY

- 22" x 22" x 11.5"
 - Chemical and heat resistant
 - Holds up to 2 gallons of liquid
- » 2830551



FUNNELS

- Narrow spout for controlled pouring
 - Designed to prevent overfills
 - Durable for all types of chemical exposure
- | | | |
|------------------------------|----------------------------|------------------------------|
| » 1.25 QT
BLUE
2830574 | » 1.5 QT
RED
2830575 | » 1.5 QT
GREEN
2830576 |
|------------------------------|----------------------------|------------------------------|



GREASE GUN

- For 14 oz All-Season & U-Joint
 - Heavy-duty, one-handed pistol grip
 - 5,000 PSI, with a 4" steel extension efficiently lubricates, reduces friction and wear and tear
- » 14 OZ • 2830569



GREASE GUN

- For 3 oz All-Season & U-Joint
 - Tough steel construction
 - Accepts both 6" rigid pip nozzle and 12" 12,000 PSI flex hose
 - Enables easy application of grease
- » 3 OZ • 2871312



EXTENSION CORDS

- Light-up cords designed for extreme cold and heat
- » HD XD 50' TRIPLE OUTLET 1 $\frac{1}{2}$ " • 2830587
- » 25' SINGLE OUTLET 1 $\frac{1}{2}$ " • 2830588
- » 50' SINGLE OUTLET 1 $\frac{1}{2}$ " • 2830589
- » 2' TRIPLE END 1 $\frac{1}{2}$ " • 2830603
- » 2' ADAPTER 30A TO 20A 1 $\frac{1}{2}$ " • 2830602



POLARIS SHOP TOWELS

- » 200 CT W/ DISPENSER • 2830402
- » 200 CT REFILL • 2830403
- » 64 CT REFILL • 2830440
- » HEAVY-DUTY SCRUBBER WIPES 90 CT • 2830441



HANDHELD PUMP SPRAYER

- Half gallon portable sprayer
- Lightweight and easy to use
- » 2830570



WORK LIGHT - 550 LUMENS

- UV and dual-charging on a 360° rotating swivel
- » 2830584



PUMP

- Fits 1 and 2.5 gallon bottles
- » 2870465



OIL CHANGE KIT

- 6.5 QT drain pan, one pint oil funnel with screen, oil filter wrench, 15" x 18" absorbent pads (2), clean up wipe (1), 6 mil nitrile gloves (1 pair), blue interfold shop towels (4)
- » 2830545



POLARIS MAGNETIC PARTS TRAY

- » 2830432



POLARIS LED POCKET FLASHLIGHT

- Powerful beam - extends 200'
- Powered by 2 AAA batteries
- 90 lumens, 1 watt, energy efficient light
- » 2830436



WORK LIGHT - 1000 LUMENS

- Adjustable with magnetic ends
- Battery charge indicator
- » 2830585



FLEX SPOUT

- Fits all Polaris quart, gallon and 2.5 gallon bottles
- » 2871285



OIL FILTER WRENCH - 65 MM (2 $\frac{9}{16}$ ") & 73 MM (2 $\frac{7}{8}$ ")

- 65 MM: 14 flute cup size, used with $\frac{3}{8}$ " square drive
- 73 MM: 15 flutes cup size, used with $\frac{3}{8}$ " square drive
- Works with Polaris Oil Filters 2540086, 2520799, 2521728 and other 14 & 15 flute filters
- » 65 MM (2 $\frac{9}{16}$ ") • 2830550
- » 73 MM (2 $\frac{7}{8}$ ") • 2830594

PRO R



POLARIS 33" TELESCOPIC MAGNET

- Retrieve fasteners or parts dropped in hard-to-reach places
- 5 LBS of holding strength
- Extends from 6.5" to 33"
- » 2830435



TRAIL TECH PORTABLE AIR COMPRESSOR

- Handheld air compressor with Li-ion battery
- Programmable PSI pressure settings, LED light and USB phone charger
- » COMPRESSOR • 060-DAP
- » CASE • 060-BAG
- » 15" EXTENDER HOSE • 060-LHS



WORK LIGHT - 4000 LUMENS

- 90° swivel LED light with magnetic backing
- 16', 14 gauge extension cord cable reel
- » 2830586

BATTERY CHARGERS



NOCO GENIUS® BATTERY CHARGER - 1 AMP

- Keep your battery charged
 - Includes Boost Eyelet Cable with X-Connector Adapter (2830546)
 - Includes adapter for vehicle charge port
- » 2830567



NOCO GENIUS® BATTERY CHARGER - 2 AMP

- Keep your battery charged
 - Includes Boost Eyelet Cable with X-Connector Adapter (2830546)
 - Includes adapter for vehicle charge port
- » 2830568



NOCO GENIUS® BATTERY CHARGER - 5 AMP, 2 BANK

- Waterproof charger
 - 5 amps per bank for charging any 12v, AGM, lead-acid and/or lithium-ion batteries
- » 2830599



NOCO GENIUS® BATTERY CHARGER - 10 AMP, 4 BANK

- Waterproof charger
 - 10 amps per bank for charging any 12v, AGM, lead-acid and/or lithium-ion batteries
- » 2830601



NOCO BOOST® GB40 12V 1000A JUMP STARTER

- Delivers 1,000 amps for jump starting a dead battery in seconds
- » 2830547



NOCO BOOST® GB70 12V 2000A JUMP STARTER

- Delivers 2,000 amps for jump starting a dead battery in seconds
- » 2830597



NOCO BOOST® JUMP PACK PROTECTION CASES

- Lightweight, durable and rugged custom exterior
- » GB40 • 2830548
» GB70 • 2830598

YOUR BATTERY
IS READY
WHEN YOU ARE

SERVICE PARTS

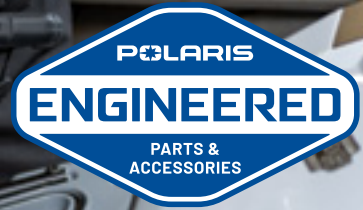

POLARIS ENGINEERED SERVICE PARTS DELIVER UNMATCHED PERFORMANCE AND FIT FOR YOUR OFF-ROAD VEHICLE.

All service parts are engineered specifically for your machine. Which means everything is designed, tested and perfected to maximize the life of your ride. Getting Polaris Engineered parts is a decision that pays off in the long run, because there is a long run.

SHOP FOR SERVICE PARTS ONLINE OR VISIT YOUR POLARIS DEALER.



LOOK-UP PARTS ON POLARIS.COM

FOR EASY PARTS IDENTIFICATION, VIEWS OF ASSEMBLIES & MORE!

Visit Polaris.com/SPORTSMAN
Click the "Parts & Accessories" tab
Enter **vehicle year/model** then **select the part**
Clearly see what parts are required and **order**

HD HEAVY DUTY PARTS

All Polaris parts are developed and tested to help you get the most out of your ride. Now, we're taking the passion of our riders, workers and outdoor enthusiasts to the next level with HD Parts. Polaris HD Parts are built for riders who push their machines to the limit—day after day, season after season. These are the ranchers, construction workers and relentless trail riders who ride in the extreme terrains and environments. From the heat of Texas to the frozen tundra of Northern Canada, and the swamps of Louisiana to the mountains of Wyoming.

LIMITED

WARRANTY

BEARINGS
BUSHINGS
DRIVE BELTS

WARRANTY

AXLES
BATTERIES

WARRANTY

AIR FILTERS
BRAKE PADS
OIL FILTERS



ENGINEERED TO HANDLE EXTREME CONDITIONS

We know you push your vehicle to the limit, demanding top performance. HD parts are developed to expand the boundaries of your ride and tackle extreme conditions:

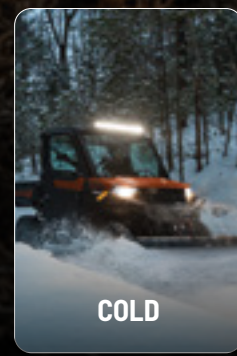



APPAREL

FIT FOR ANY ADVENTURE. For outdoor enthusiasts looking for gear that's purposefully built to stand up to the fun and challenging experiences Polaris vehicles enable. Each piece of apparel and equipment bearing the name Polaris is crafted by outdoor enthusiasts, for outdoor enthusiasts. They are a badge of honor - representing what the Polaris brand stands for - a passion to simply be outside doing what you love.



SCAN TO SHOP
THE FULL LINEUP OF
POLARIS APPAREL

JERSEYS, GLOVES & GAITERS

THROTTLE JERSEYS

ADULT: S-3XL
YOUTH: S-XL

- Mesh ventilated panels for maximum airflow
- Elastic sleeves with non-restrictive cuffs

THROTTLE GLOVES

ADULT: S-3XL
YOUTH: S-XL

- Adjustable wrist closure for a custom fit
- Silicon finger grips and neoprene knuckle protection



OLIVE

Adult | 2866415
Youth | 2866416

WHITE/BLUE

Adult | 2865376

TAN/ORANGE

Adult | 2865377
Youth | 2865382

FUCHSIA/GRAY

Adult | 2865379
Youth | 2865381

TEAL/LIME

Adult | 2865378

BLACK

Adult | 2865374

BLUE

Adult | 2865375
Youth | 2865380



RED

Adult | 2866411



OLIVE

Adult | 2866410
Youth | 2866417



WHITE/BLUE

Adult | 2865385



TAN/ORANGE

Adult | 2865386
Youth | 2865391



FUCHSIA/GRAY

Adult | 2865388
Youth | 2865390



TEAL/LIME

Adult | 2865387



BLACK

Adult | 2865383



BLUE

Adult | 2865384
Youth | 2865389

NECK GAITERS

- Keep the sun off your neck and the dust off your face
- Stretchy and seamless material
- UPF 15-18 for sun protection and moisture-wicking



BLUE
2833138



LIME
2861952



CAMO
2861948



BLACK
2861953



RED RETRO
2861950

RANGE COLLECTION



RANGE WORK JACKET

Rugged and warm jacket that's tough for work and comfortable for play

MEN'S | S-3XL

Black | 2865321
Tan | 2865322

WOMEN'S | S-3XL

Black | 2865345
Tan | 2865346



RANGE WORK GLOVE

MEN'S | S-3XL
Black | 2865392

CASUALWEAR & HATS



SOFTSHELL JACKET 2.0

MEN'S | S-3XL

- NEW** Forest Green | 2866404
- Black | 2865318
- Rust | 2865319
- Blue | 2865320

WOMEN'S | S-3XL

- Black | 2865343
- Blue | 2865344

PURSUIT HOODIE

MEN'S | S-3XL

- NEW** Tan | 2866439
- Orange | 2864606
- Camo | 2862494
- Black | 2833076
- Green | 2833077

WOMEN'S | S-3XL

- Camo | 2865488

UPF HOODIE TEE TOP SELLER

MEN'S | S-3XL

- Olive | 2865492
- Blue | 2833072
- Gray | 2833073

WOMEN'S | S-3XL

- NEW** Gray | 2866421
- Navy | 2865494
- Teal | 2833103



PLAID FLANNEL SHIRT

MEN'S | S-3XL

- Cabernet | 2865495
- Blue | 2864671
- Cypress | 2864672



WOMEN'S | S-3XL

- Cabernet | 2865496
- Blue | 2864673
- Teal | 2864674



PERFORMANCE SHIRT

MEN'S | S-3XL

- Sand | 2865497
- Cypress | 2865498



BLOCK '54 HOODIE NEW

MEN'S | S-3XL

- Black | 2866440
- Sand | 2866441



PIT SHIRT TOP SELLER

MEN'S | SIZE VARIES

- NEW** Tan | S-3XL | 2866413
- Cypress | S-3XL | 2864561
- Black | XS-4XL | 2862526
- Navy | S-3XL | 2833043



STAPLE CAP TOP SELLER

- NEW** Sand | 2866471
- Maroon | 2865516
- Cypress | 2864568
- Black | 2833127
- Navy | 2833128



CORE CAP TOP SELLER

- Red | 2833123
- Gray | 2833507
- Navy | 2833494
- Black | 2833495



BLOCK '54 CAP NEW

- Black | 2866476



TONAL HAT

- NEW** Olive | 2866469
- Orange | 2864564
- Black/Red | 2833497
- Navy | 2833496



STEALTH CAMO CAP

- Camo | 2861527



HUNTER ORANGE HAT

- S/M | 2860892
- L/XL | 2862545



CAMO BEANIE (REVERSIBLE)

- Camo | 2833118



CORE BEANIE

- Orange | 2862595

HELMETS & GOGGLES



NEW
OLIVE/BLACK
2866467

TENACITY 4.0

COMBINATION OF MODERN STYLE AND PREMIUM PROTECTION WITH INCREDIBLE VALUE XS-2XL

SHELL

- Shock-resistant, injection-molded thermoplastic

WEIGHT

- 1,500g

FEATURES

- Through-flow, full-helmet ventilation
- ProClip quick release chin strap allows you to fasten the chin strap in seconds
- Removable breath box
- Toolless adjustable roost shield
- Removable, washable liner
- DOT/ECE 22.06 dual certified helmet shell

FULL DETAILS ONLINE



APPAREL

JEANS, GLOVES & GAITERS

RANGE COLLECTION



NEW
RED
2866418

509 KINGPIN

PREMIUM MATERIALS, ATTRACTIVE PRICE

FEATURES

- Built for off-road, the oversized cylindrical lens delivers optimal peripheral vision
- Metal tear-off posts provide strength and durability
- Quick-change technology allows you to run the best lens tint for conditions

FULL DETAILS ONLINE



CASUALWEAR & HATS

HELMETS & GOGGLES



NEW
RADIANT TEAL
2866423

509 MX6

SUPER WIDE FIELD OF VIEW, ENGINEERED FOR DIRT

FEATURES

- PC outer lens with anti-scratch coating, and internal anti-fog coating
- Outriggers with latch system for quick lens change
- 45mm strap with silicone to hold strap in place

FULL DETAILS ONLINE



SEE OUR FULL LINE OF HOME & COLLECTIBLES ONLINE



KICKBACK ROCKER

Green | 2864816
Blue | 2862626



POLARIS KEY RACK

12" x 8" | 2864718



15 OZ CAMPFIRE MUG

2861613

WHEN YOU'RE TRUSTED BY MILLIONS, YOU GET TO WORK.



POLARIS SPORTSMAN

ATVs for trail and adventure riders, hunters, ranchers and anyone who wants to explore the outdoors.



POLARIS RZR

The #1 sport side-by-side lineup, with the most complete lineup for whatever terrain you ride. From tight mountain trails, to deep in the backwoods, to steep dunes.



POLARIS RANGER

The most capable UTVs, purpose-built to be the hardest working and the smoothest riding.



**THEY SAY IT TAKES 10,000 HOURS TO MASTER SOMETHING.
WE'VE BEEN BUILDING FOR OVER 70 YEARS.**

**WE RELENTLESSLY TEST OUR VEHICLES TO BETTER THE RIDE,
SO YOU CAN DO WHAT YOU WERE PUT HERE FOR.**



**POLARIS
XPEDITION**

Elevated performance and all-season comfort to go beyond the trailhead.



**POLARIS
GENERAL**

The #1 crossover brand. Versatility, comfort and capability to hit the trails or knock out tasks.



SPORTSMAN 450 H.O.



**SPORTSMAN 450 H.O.
EPS**



SPORTSMAN 570



**SPORTSMAN 570
EPS**

ENGINE TYPE / HP	499cc, 4-Stroke SOHC, Single Cylinder / 33 HP	499cc, 4-Stroke SOHC, Single Cylinder / 33 HP	567cc, 4-Stroke DOHC, Single Cylinder / 44 HP	567cc, 4-Stroke DOHC, Single Cylinder / 44 HP
DRIVETRAIN (DRIVE SYSTEM)	One Touch On-Demand AWD/2WD	One Touch On-Demand AWD/2WD	One Touch On-Demand AWD/2WD	One Touch On-Demand AWD/2WD
FRONT/REAR SUSPENSION	Sealed MacPherson Strut 8.2" (20.8 cm) Travel / Sealed Dual A-Arm, IRS 9.5" (24.1 cm) Travel	Sealed MacPherson Strut 8.2" (20.8 cm) Travel / Sealed Dual A-Arm, IRS 9.5" (24.1 cm) Travel	Sealed MacPherson Strut 8.2" (20.8 cm) Travel / Sealed Dual A-Arm, IRS 9.5" (24.1 cm) Travel	Sealed MacPherson Strut 8.2" (20.8 cm) Travel / Sealed Dual A-Arm, IRS 9.5" (24.1 cm) Travel
FRONT TIRES & REAR TIRES	25 x 8-12; 489 25 x 8-12; 489	25 x 8-12 25 x 10-12	25 x 8-12 25 x 10-12; 489	25 x 8-12 25 x 10-12
OVERALL VEHICLE SIZE (L X W X H)	83 x 48 x 47" (210.8 x 121.9 x 119.4 cm)	83 x 48 x 47" (210.8 x 121.9 x 119.4 cm)	83 x 48 x 47" (210.8 x 121.9 x 119.4 cm)	83 x 48 x 47" (210.8 x 121.9 x 119.4 cm)
GROUND CLEARANCE	11.5" (29 cm)	11.5" (29 cm)	11.5" (29 cm)	11.5" (29cm)
SEATING CAPACITY	1	1	1	1
BOX / RACK CAPACITY	90 LB (40.8 KG) / 180 LB (81.6 KG)	90 LB (40.8 KG) / 180 LB (81.6 KG)	90 LB (40.8 KG) / 180 LB (81.6 KG)	90 LB (40.8 KG) / 180 LB (81.6 KG)
TOW CAPACITY	1,350 LB (612 KG)	1,350 LB (612 KG)	1,350 LB (612 KG)	1,350 LB (612 KG)
OTHER STANDARD FEATURES	Halogen Pod and Bumper Lights, Pre-Wired for Hand and Thumb Warmers, Front Rack Extender	Halogen Pod and Bumper Lights, Pre-Wired for Hand and Thumb Warmers, Front Rack Extender, Rear Rack Extender	Halogen Pod and Bumper Lights, Pre-Wired for Hand and Thumb Warmers, Front Rack Extender	LED Pod and Bumper Lights, Front Trail Bumper, Front Rack Extender, Rear Rack Extender, Front A-Arm Guards, Pre-Wired for Hand and Thumb Warmers



**SPORTSMAN 570
PREMIUM - 40TH ANNIVERSARY EDITION**



**SPORTSMAN 570
TRAIL**



**SPORTSMAN 570
ULTIMATE**



SPORTSMAN 850

ENGINE TYPE / HP	567cc, 4-Stroke DOHC, Single Cylinder / 44 HP	567cc, 4-Stroke DOHC, Single Cylinder / 44 HP	567cc, 4-Stroke DOHC, Single Cylinder / 44 HP	850cc, 4-Stroke DOHC, Twin Cylinder / 78 HP
DRIVETRAIN (DRIVE SYSTEM)	One Touch On-Demand AWD/2WD	One Touch On-Demand AWD/2WD	One Touch On-Demand AWD/2WD	One Touch On-Demand AWD/2WD
FRONT/REAR SUSPENSION	Sealed MacPherson Strut 8.2" (20.8 cm) Travel / Sealed Dual A-Arm, IRS 9.5" (24.1 cm) Travel	Sealed Arched Dual A-Arm 8.9" (22.6 cm) Travel / Sealed Dual A-Arm, IRS 9.5" (24.1 cm) Travel	Sealed Arched Dual A-Arm with 8.9" (22.6 cm) Travel / Sealed Dual A-Arm, IRS 9.5" (24.1 cm) Travel	Straight Dual A-Arm 9" (22.9 cm) Travel / Straight Dual A-Arm, Rolled IRS, 10.25" (26 cm) Travel
FRONT TIRES & REAR TIRES	26 x 8-14; DURO® 26 x 10-14; DURO®	26 x 8-14; DURO® 26 x 10-14; DURO®	26 x 8-14; DURO® 26 x 10-14; DURO®	26 x 8; CST® 26 x 10; CST®
OVERALL VEHICLE SIZE (L X W X H)	83 x 48 x 47" (210.8 x 121.9 x 119.4 cm)	83 x 48 x 47" (210.8 x 121.9 x 119.4 cm)	83 x 48 x 47" (210.8 x 121.9 x 119.4 cm)	83.25 x 47.6 x 50.7" (211.4 x 120.9 x 128.9 cm)
GROUND CLEARANCE	11.5" (29 cm)	11.5" (29 cm)	11.5" (29 cm)	12" (30.5 cm)
SEATING CAPACITY	1	1	1	1
BOX / RACK CAPACITY	90 LB (40.8 KG) / 180 LB (81.6 KG)	90 LB (40.8 KG) / 180 LB (81.6 KG)	90 LB (40.8 KG) / 180 LB (81.6 KG)	120 LB (55 KG) / 240 LB (110 KG)
TOW CAPACITY	1,350 LB (612 KG)	1,350 LB (612 KG)	1,350 LB (612 KG)	1,500 LB (680 KG)
OTHER STANDARD FEATURES	LED Pod and Headlights, Front Trail Bumper, 3,500 LB Winch with Steel Cable, 12V Power Plug, Pre-Wired for Hand and Thumb Warmers, In-Pod Battery Charger, Front Rack Extender, Rear Rack Extender, Painted Plastics, Front and Rear A-Arm Guards, 40th Anniversary Graphics and Badging	LED Pod and Headlights, Front Trail Bumper, 3,500 LB Winch with Steel Cable, 12V Power Plug, Pre-Wired for Hand and Thumb Warmers, In-Pod Battery Charger, Front Rack Extender, Painted Plastics, Front and Rear A-Arm Guards, 11 Gallon Sealed Storage	7" Display Powered by RIDE COMMAND, High output LED Pod and Bumper Lights, Pre-Wired for Hand and Thumb Warmers, 3,500 LB Polaris HD Winch with Auto Stop and Synthetic Rope, Front Trail Bumper, Front and Rear Rack Extenders, Painted Plastics, Painted Springs, In Pod USB Charger, PIN Activated Security System (P.A.S.S.), Front and Rear A-Arm Guards, Rear Storage, 11 Gallon Sealed Storage	50-W High Beam, Dual 50-W Low Beam Headlights, Dual LED Brake Lights/Tailights, 12V Power Plug, In Pod Battery Charger, Pre Wires for Hand and Thumb Warmers, 4 Moveable Tie-Down Points



**SPORTSMAN 850
PREMIUM**



**SPORTSMAN 850
TRAIL**



**SPORTSMAN XP 1000
ULTIMATE**

ENGINE TYPE / HP	850cc, 4-Stroke DOHC, Twin Cylinder / 78 HP	850cc, 4-Stroke DOHC, Twin Cylinder / 78 HP	952cc, 4-Stroke DOHC, Twin Cylinder / 90 HP
DRIVETRAIN (DRIVE SYSTEM)	One Touch On-Demand AWD/2WD	One Touch On-Demand AWD/2WD	One Touch On-Demand AWD/2WD
FRONT/REAR SUSPENSION	Straight Dual A-Arm 9" (22.9 cm) Travel / Straight Dual A-Arm, Rolled IRS, 10.25" (26 cm) Travel	Sealed High Clearance Arched Dual A-Arm 9" (22.9 cm) Travel / Sealed High Clearance Arched Dual A-Arm, Rolled IRS, 10.25" (26 cm) Travel	Sealed High Clearance Arched Dual A-Arm 9" (22.9 cm) Travel / Sealed High Clearance Arched Dual A-Arm, Rolled IRS, 10.25" (26 cm) Travel
FRONT TIRES & REAR TIRES	26 x 8; CST® 26 x 10; CST®	27 x 8; Pro Armor X-Terrain 27 x 11; Pro Armor X-Terrain	27 x 8-14; DURO® 27 x 11-14; DURO®
OVERALL VEHICLE SIZE (L X W X H)	83.25 x 47.6 x 50.7" (211.4 x 120.9 x 128.9 cm)	83.25 x 47.6 x 50.7" (211.4 x 120.9 x 128.9 cm)	83.25 x 47.6 x 50.75" (211.4 x 120.9 x 128.9 cm)
GROUND CLEARANCE	12" (30.5 cm)	12" (30.5 cm)	12" (30.5 cm)
SEATING CAPACITY	1	1	1
BOX / RACK CAPACITY	120 LB (55 KG) / 240 LB (110 KG)	120 LB (55 KG) / 240 LB (110 KG)	120 LB (55 KG) / 240 LB (110 KG)
TOW CAPACITY	1,500 LB (680 KG)	1,500 LB (680 KG)	1,500 LB (680 KG)
OTHER STANDARD FEATURES	LED Pod and Bumper Lights, 12V Power Plug, In Pod Battery Charger, Pre Wires for Hand and Thumb Warmers, 6 Moveable Tie-Down Points, Painted Plastics, Fender Flares	LED Pod and Bumper Lights, 12V Power Plug, In Pod Battery Charger, Pre Wires for Hand and Thumb Warmers, 3,500 LB Winch with Synthetic Rope, Front Ultimate Series Bumper, Rear Ultimate Series Bumper, Painted Plastics, Painted Springs, Fender Flares, 6 Moveable Tie-Down Points, Premium Cut and Sew Saddle Seat	7" Display Powered by RIDE COMMAND, RIDE COMMAND+ Connected Vehicle Services, High Output LED Pod and Bumper Lights, Premium Cut and Sew Seat, 3,500 LB Winch with Synthetic Rope and Auto Stop, Front Ultimate Series Bumper, Painted Plastics, Painted Springs, Fender Flares, PIN-Activated Security System (P.A.S.S.), In Pod USB Charger, 6 Moveable Tie-Down Points

SPORTSMAN TOURING MODELS



SPORTSMAN TOURING 570

ENGINE TYPE / HP	567cc, 4-Stroke DOHC, Single Cylinder / 44 HP
DRIVETRAIN (DRIVE SYSTEM)	One Touch On-Demand AWD/2WD
FRONT/REAR SUSPENSION	Sealed MacPherson® Strut 8.2" (20.8 cm) Travel / Sealed Dual A-Arm, IRS 9.5" (24.1 cm) Travel
FRONT TIRES & REAR TIRES	25 x 8-12 25 x 10-12
OVERALL VEHICLE SIZE (L X W X H)	89 x 48 x 59" (226 x 121.2 x 150 cm)
GROUND CLEARANCE	11.5" (29 cm)
SEATING CAPACITY	2
FRONT/ REAR RACK CAPACITY	90 LB (40.8 KG) / 180 LB (81.6 KG)
TOW CAPACITY	1,350 LB (612 KG)
OTHER STANDARD FEATURES	Halogen Pod and Headlights, 11 Gallon Sealed Storage, Removable Passenger Seat, Front Rack Extender, Front A-Arm Guards



SPORTSMAN TOURING 570 PREMIUM

ENGINE TYPE / HP	567cc, 4-Stroke DOHC, Single Cylinder / 44 HP
DRIVETRAIN (DRIVE SYSTEM)	One Touch On-Demand AWD/2WD
FRONT/REAR SUSPENSION	Sealed MacPherson® Strut 8.2" (20.8 cm) Travel / Sealed Dual A-Arm, IRS 9.5" (24.1 cm) Travel
FRONT TIRES & REAR TIRES	26 x 8-14; DURO® 26 x 10-14; DURO®
OVERALL VEHICLE SIZE (L X W X H)	91 x 48 x 59" (231.1 x 121.2 x 150 cm)
GROUND CLEARANCE	11.5" (29 cm)
SEATING CAPACITY	2
FRONT/ REAR RACK CAPACITY	90 LB (40.8 KG) / 180 LB (81.6 KG)
TOW CAPACITY	1,350 LB (612 KG)
OTHER STANDARD FEATURES	LED Pod and Headlights, 3,500 LB Winch with Steel Cable, Front and Rear A-Arm Guards, Front Trail Bumper, Front and Rear Rack Extender, Painted Plastics, 11 Gallon Sealed Storage, Removable Passenger Seat



SPORTSMAN TOURING 570 ULTIMATE

ENGINE TYPE / HP	567cc, 4-Stroke DOHC, Single Cylinder / 44 HP
DRIVETRAIN (DRIVE SYSTEM)	One Touch On-Demand AWD/2WD
FRONT/REAR SUSPENSION	Sealed Archd Dual A-Arm with 8.9" (22.6 cm) Travel / Sealed Dual A-Arm, IRS 9.5" (24.1 cm) Travel
FRONT TIRES & REAR TIRES	26 x 8-14; DURO® 26 x 10-14; DURO®
OVERALL VEHICLE SIZE (L X W X H)	91 x 48 x 59" (231.1 x 121.2 x 150 cm)
GROUND CLEARANCE	11.5" (29 cm)
SEATING CAPACITY	2
FRONT/ REAR RACK CAPACITY	90 LB (40.8 KG) / 180 LB (81.6 KG)
TOW CAPACITY	1,350 LB (612 KG)
OTHER STANDARD FEATURES	7" Display Powered by RIDE COMMAND, High Output LED Pod and Bumper Lights, Pre-Wired for Hand and Thumb Warmers, 3,500 LB Winch with Synthetic Rope and Auto Stop, Front and Rear A-Arm Guards, Front Trail Bumper, Front and Rear Rack Extenders, Painted Plastics, In Pod USB Charger, PIN-Activated Security System (P.A.S.S.), 11 Gallon Sealed Storage



SPORTSMAN TOURING 850 PREMIUM

ENGINE TYPE / HP	850cc, 4-Stroke DOHC, Twin Cylinder / 78 HP
DRIVETRAIN (DRIVE SYSTEM)	One Touch On-Demand AWD/2WD
FRONT/REAR SUSPENSION	Straight Dual A-Arm 9" (22.9 cm) Travel / Straight Dual A-Arm, Rolled IRS, 10.25" (26 cm) Travel
FRONT TIRES & REAR TIRES	26 x 8-14; CST® 26 x 10-14; CST®
OVERALL VEHICLE SIZE (L X W X H)	84.3 x 48.2 x 48.8" (214 x 123 x 124 cm)
GROUND CLEARANCE	11.25" (28.5 cm)
SEATING CAPACITY	2
FRONT/ REAR RACK CAPACITY	120 LB (55 KG) / 240 LB (110 KG)
TOW CAPACITY	1,500 LB (680 KG)
OTHER STANDARD FEATURES	LED POD and Bumper Lights, Painted Plastics, 12V Power Plug



SPORTSMAN TOURING XP 1000 TRAIL

ENGINE TYPE / HP	952cc, 4-Stroke DOHC, Twin Cylinder / 88 HP
DRIVETRAIN (DRIVE SYSTEM)	One Touch On-Demand AWD/2WD
FRONT/REAR SUSPENSION	Sealed High Clearance Archd Dual A-Arm 9" (22.9 cm) Travel / Sealed High Clearance Archd Dual A-Arm, Rolled IRS, 10.25" (26 cm) Travel
FRONT TIRES & REAR TIRES	27 x 9-14; DURO® 27 x 11-14; DURO®
OVERALL VEHICLE SIZE (L X W X H)	84.3 x 48.2 x 48.8" (214 x 123 x 124 cm)
GROUND CLEARANCE	11.25" (28.5 cm)
SEATING CAPACITY	2
FRONT/ REAR RACK CAPACITY	120 LB (55 KG) / 240 LB (110 KG)
TOW CAPACITY	1,500 LB (680 KG)
OTHER STANDARD FEATURES	LED Pod and Bumper Lights, 3,500 LB Winch with Synthetic Rope, Front Bumper, Driver Handguards, Mirrors, Painted Plastics, Painted Springs, 12V Power Plug

SPORTSMAN SPORT MODELS



SPORTSMAN XP 1000 S

ENGINE TYPE / HP	952cc, 4-Stroke DOHC, Twin Cylinder / 88 HP
DRIVETRAIN (DRIVE SYSTEM)	One Touch On-Demand AWD/2WD
FRONT/REAR SUSPENSION	Walker Evans Shocks, Sealed High Clearance Archd Dual A-Arm 11.6" (29.5 cm) Travel / Sealed Dual A-Arm Rolled IRS, 14" (35.6 cm) Travel
FRONT TIRES & REAR TIRES	27 x 9-14; DURO® PowerGrip II 27 x 11-14; DURO® PowerGrip II
OVERALL VEHICLE SIZE (L X W X H)	82.5 x 55 x 49.5" (209.5 x 140 x 125.7 cm)
GROUND CLEARANCE	14.5" (36.8 cm)
SEATING CAPACITY	1
FRONT/ REAR RACK CAPACITY	200 LB (91 KG) / 300 LB (136 KG)
TOW CAPACITY	1,750 LB (794 KG)
OTHER STANDARD FEATURES	High Output LED Pod and Bumper Lights, Premium Cut and Sew Seat, Front Bumper, Rear Bumper, Painted Plastics, Fender Flares, 3,500 LB Winch with Synthetic Rope, PIN Activated Security System (P.A.S.S.), 6 Moveable Tie Down Points



SCRAMBLER 850

ENGINE TYPE / HP	850cc, 4-Stroke DOHC, Twin Cylinder / 78 HP
DRIVETRAIN (DRIVE SYSTEM)	One Touch On-Demand AWD/2WD
FRONT/REAR SUSPENSION	Dual A-Arm 9" (22.9 cm) Travel / Dual A-Arm, Rolled IRS 10.25" (26 cm) Travel
FRONT TIRES & REAR TIRES	26 x 8; CST® 26 x 10; CST®
OVERALL VEHICLE SIZE (L X W X H)	82.3 x 48 x 48.4" (209 x 122 x 123 cm)
GROUND CLEARANCE	11.5" (29 cm)
SEATING CAPACITY	1
FRONT/ REAR RACK CAPACITY	25 LB / 50 LB (11.3 KG / 22.7 KG)
TOW CAPACITY	1,500 LB (680 KG)
OTHER STANDARD FEATURES	LED High/Low Beam Headlights, Premium Cut and Sew Seat



SCRAMBLER XP 1000 S

ENGINE TYPE / HP	952cc, 4-Stroke DOHC, Twin Cylinder / 88 HP
DRIVETRAIN (DRIVE SYSTEM)	One Touch On-Demand AWD/2WD
FRONT/REAR SUSPENSION	Walker Evans Shocks, Sealed High Clearance Archd Dual A-Arm 12.5" (29.2 cm) Travel / Sealed Dual A-Arm Rolled IRS, 14" (35.6 cm) Travel
FRONT TIRES & REAR TIRES	27 x 9-12; DURO® PowerGrip II 27 x 9-12; DURO® PowerGrip II
OVERALL VEHICLE SIZE (L X W X H)	82.5 x 55 x 49.5" (209.5 x 140 x 125.7 cm)
GROUND CLEARANCE	14.5" (36.8 cm)
SEATING CAPACITY	1
FRONT/ REAR RACK CAPACITY	25 LB / 50 LB (11.3 KG / 22.7 KG)
TOW CAPACITY	N/A
OTHER STANDARD FEATURES	LED High/Low Beam Headlights, Pro Armor Light Bar, Pre Wires for Hand and Thumb Warmers, Front Bumper, Painted Plastics, Painted Springs, Premium Cut and Sew Seat



SPORTSMAN X2 570



SPORTSMAN 6X6 570



**SPORTSMAN 850
MUD EDITION**



**SPORTSMAN XP 1000
MUD EDITION**

ENGINE TYPE / HP	567cc, 4-Stroke DOHC, Single Cylinder / 44 HP	567cc, 4-Stroke DOHC, Single Cylinder / 44 HP	850cc, 4-Stroke SOHC, Twin Cylinder / 78 HP	952cc, 4-Stroke SOHC, Twin Cylinder / 85 HP
DRIVETRAIN (DRIVE SYSTEM)	One Touch On-Demand AWD/2WD/Turf Mode	One Touch On-Demand AWD/2WD	One Touch On-Demand AWD/2WD	One Touch On-Demand AWD/2WD
FRONT/REAR SUSPENSION	Sealed MacPherson® Strut With 8.2" (20.8 cm) Travel / Sealed Dual A-Arm, IRS 9.5" (24.1 cm) Travel	Sealed Arched Dual A-Arm with 8.9" (22.6 cm) Travel / Sealed Dual A-Arm, IRS 6.3" (16 cm) Travel	High Clearance Arched Dual A-Arm 7.4" (18.8 cm) Travel / High Clearance Arched Dual A-Arm, Rolled IRS, 6.7" (17 cm) Travel	High Clearance Arched Dual A-Arm 7.4" (18.8 cm) Travel / Rear High Clearance Arched Dual A-Arm, Rolled IRS, 6.7" (17 cm) Travel
FRONT TIRES & REAR TIRES	26 x 8-14; DURO® 26 x 10-14; DURO®	26 x 8-14; CST 26 x 10-14; CST	30 x 9.0; Pro Armor MUD XT 2.0 30 x 9.0; Pro Armor MUD XT 2.0	30 x 9.0; Pro Armor MUD XT 2.0 30 x 9.0; Pro Armor MUD XT 2.0
OVERALL VEHICLE SIZE (L X W X H)	92 x 49 x 51" (234.8 x 123.8 x 130.6 cm)	119 x 49.6 x 52.7" (302 x 126.2 x 133.9 cm)	88 x 50 x 50.4" (224 x 127 x 128 cm)	88 x 50 x 50.4" (224 x 127 x 128 cm)
GROUND CLEARANCE	11.5" (29 cm)	11.5" (29 cm)	13.5" (34.3 cm)	13.5" (34.3 cm)
SEATING CAPACITY	2	2	1	1
FRONT/ REAR RACK CAPACITY	90 LB (40.8 KG) / 400 LB (180 KG)	90 LB (40.8 KG) / 800 LB (362.8 KG)	0 LB (0 KG) / 75 LB (34 KG)	0 LB (0 KG) / 75 LB (34 KG)
TOW CAPACITY	1,350 LB (612 KG)	1,500 LB (680 KG)	1,500 LB (680 KG)	1,500 LB (680 KG)
OTHER STANDARD FEATURES	LED Pod and Headlights, Front Trail Bumper, 3,500 LB Winch with Synthetic Rope and Auto Stop, Front Rack Extender, Bed Box, Ride Control (Easy Effort Throttle, Speed Limiting, Geofencing, PIN Activated Security System), Drive Modes, Painted Plastics, Front and Rear A-Arm Guards, Turf Mode	LED Pod and Headlights, Front and Rear A-Arm Guards, Front Trail Bumper, 3,500 LB Winch with Synthetic Rope and Auto Stop, Front Rack Extender, Bed Box, Ride Control (Easy Effort Throttle, Speed Limiting, Geofencing, PIN Activated Security System), Drive Modes	LED Headlights, Dual Brake Lights/Tailights	LED Headlights, Dual Brake Lights/Tailights, Front Bumper, Rear Bumper, 3,500 LB Winch with Synthetic Rope, Premium Cut and Sew Seat, Painted Plastics, Painted Springs, Mud Handlebar Grab Hoop

YOUTH MODELS



2025 OUTLAW 70 EFI



OUTLAW 110 EFI



SPORTSMAN 110 EFI



PHOENIX 200

ENGINE TYPE / HP	70cc, 4-Stroke, Single Cylinder EFI	112cc, 4-Stroke, Single Cylinder EFI	112cc, 4-Stroke, Single Cylinder EFI	198cc, 4-Stroke, Single Cylinder
DRIVETRAIN (DRIVE SYSTEM)	2WD, Chain	2WD	2WD	2WD, Chain
FRONT/REAR SUSPENSION	Single A-Arm with 4" (10.16 cm) Travel / Mono Shock Swingarm with 4" (10.16 cm) Travel	Single A-Arm with 5" (12.7 cm) Travel / Mono-Shock Swingarm with 6" (15.2 cm) Travel	Single A-Arm with 5" (12.7 cm) Travel / Mono-Shock Swingarm with 6" (15.2 cm) Travel	Dual A-Arm with 7" (17.8 cm) Travel / Mono-Shock Swingarm with 6.5" (16.5 cm) Travel
FRONT TIRES & REAR TIRES	18 x 7-8; R8 18 x 8-8; R8	19 x 7-8; DURO® 18 x 9.5-8; DURO®	19 x 7-8; DURO® 18 x 9.5-8; DURO®	21 x 7-10; DURO® 20 x 10-9; DURO®
OVERALL VEHICLE SIZE (L X W X H)	56 x 35.5 x 35.25" (142.24 x 90.17 x 89.5 cm)	61.25 x 36.75 x 38.5" (155.6 x 93.3 x 97.8 cm)	61.25 x 36.75 x 38.5" (155.6 x 93.3 x 97.8 cm)	65 x 42 x 42" (165.1 x 106.7 x 106.7 cm)
GROUND CLEARANCE	4" (10.2 cm)	3.5" (8.9 cm)	3.5" (8.9 cm)	5.7" (14.5 cm)
SEATING CAPACITY	1	1	1	1
FRONT/ REAR RACK CAPACITY	25 LB (11.3 KG)	N/A	15 LB (6.8 KG)	N/A
TOW CAPACITY	N/A	N/A	N/A	N/A
OTHER STANDARD FEATURES	Safety Flag, Safety Tether, Parent Adjustable Speed Limiter, Free Online Safety Training	Safety Flag, Safety Tether, Parent Adjustable Speed Limiter, Free Online Safety Training	Safety Flag, Safety Tether, Parent Adjustable Speed Limiter, Free Online Safety Training	Safety Flag, Parent Adjustable Speed Limiter, Free Online Safety Training



LIVE LIFE OFF ROAD.

Warning: Polaris Off-Road vehicles can be hazardous to operate and are not designed for on-road use. Driver must be at least 16 years old with a valid driver's license to operate. All riders should always wear helmets, eye protection and protective clothing and footwear. Read, understand and follow your owner's manual. Ride within the limits of your own abilities and never engage in stunt or exhibition driving. Never ride under the influence of drugs or alcohol. All riders should take a safety training course. Call 800-342-3764 for additional information.

Unless noted, all trademarks are the property of Polaris Industries Inc. 509® is a registered trademark of Teton Outfitters, LLC. App Store® is a registered trademark of Apple Inc. Bluetooth® is a registered trademark of Bluetooth SIG, Inc. Caliber® is a registered trademark of Caliber, Inc. Cardo® is a registered trademark of CARDO SYSTEMS LTD. CruzTools® is a registered trademark of CYCOACTIVE, INC. Facebook™ is a service trademark of META PLATFORMS, INC. Fidlock® is a registered trademark of Fidlock GmbH. FOX® is a registered trademark of Fox Factory Inc. Google Play™ is a service trademark of Google LLC. YouTube® is a registered trademark of GOOGLE LLC. Instagram™ is a service trademark of Instagram, LLC. NOCO Genius® is a registered trademark of The Noco Company. OGIO® is a registered trademark of Ogio International, Inc. Rigid® is a trademark of JST Performance, LLC d/b/a Rigid Industries, LLC. Rockford Fosgate® is a registered trademark of Rockford Corporation. SMART BOARD® is a registered trademark of SMART TECHNOLOGIES ULC UNLIMITED LIABILITY CORPORATION CANADA. Tiger Drylac® is a registered trademark of TIGER COATINGS GMBH & CO. KG. X™ is a service trademark of X CORP. Velcro® is a registered trademark of VELCRO IP HOLDINGS LLC. Prices, Fitment and Availability are subject to change at any moment. Copyright © 2025 Polaris Industries Inc. All rights reserved.

THE AMERICAN POWERSPORTS CO.



At Polaris, we believe being an American company isn't a sales pitch; it's a way of doing business. It's the place we call home. The place our riders call home.

It all began here in America—over 70 years ago—in a small factory in Roseau, Minnesota. There, our founders forged a company built on American values, grit and ingenuity. That factory is not so small anymore and still operates to this day—creating jobs and producing the best our industry has to offer. The best America has to offer.

Today, we continue to design, engineer and test our industry-leading vehicles with owners like you—right here on American dirt, sand, snow and soil.



POLARIS GLOBAL HEADQUARTERS
MEDINA, MINNESOTA, USA



CONNECT ONLINE
SEARCH "POLARISORV"

LEARN MORE
ABOUT THE POLARIS STORY



VISIT [POLARIS.COM/SPORTSMAN](https://www.polaris.com/sportsman)

TO SEE VEHICLE OPTIONS AND VIEW ACCESSORIES
ON YOUR NEW MACHINE FROM EVERY ANGLE!

POLARIS
Think Outside

MY26 SPORTSMAN CATALOG ENGLISH OCT '25
9959121